



Smokey Mountain Lumber
MOULDINGS



6th EDITION



Smokey Mountain Lumber

INCORPORATED

Asheville, North Carolina
828.298.3958 • fax 828.298.6315



Smokey Mountain Lumber, Inc., established in 1982, specializes in residential and commercial trim at prices competitive with the larger home improvement centers. We can match an existing pattern or create an entirely new one. We offer your choice of pattern(s), in your choice of wood specie(s), on a timely basis, at competitive prices.

Enclosed you will find a few samples of moulding we can manufacture.

If you have any questions, please don't hesitate to call or write:

Lynn Fidler
Smokey Mountain Lumber, Inc.
P.O. Box 9207
Asheville, NC 28815
(828) 298--3958
(828) 298-6315 FAX

We look forward to serving your building needs.

Thank you,
Smokey Mountain Lumber, Inc.



Smokey Mountain Lumber
INCORPORATED

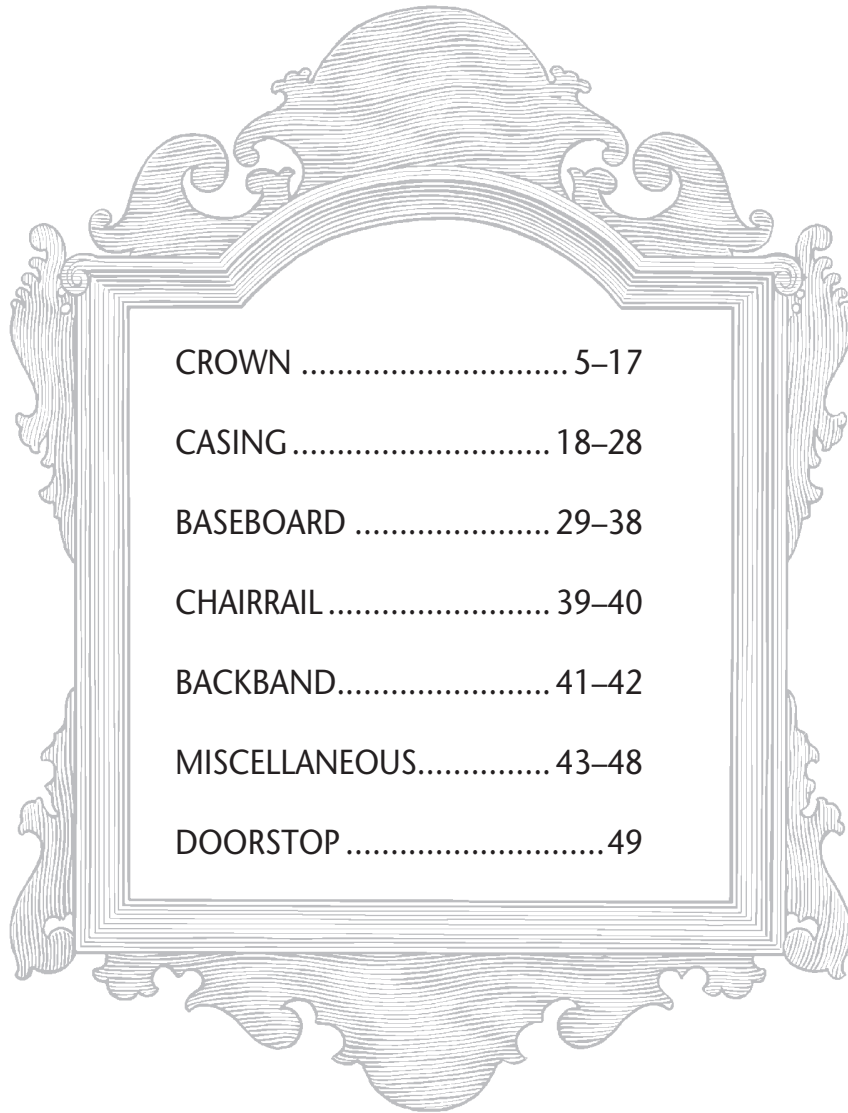

CROWN

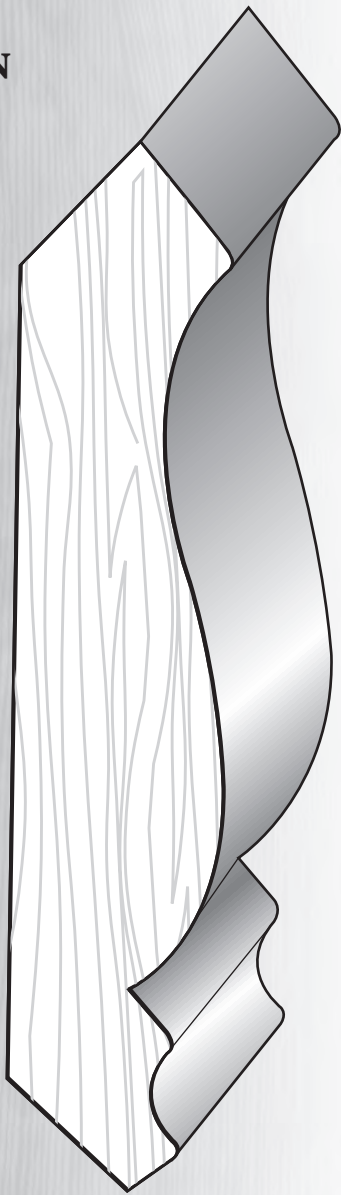

#100 $1\frac{1}{16} \times 5\frac{1}{2}$

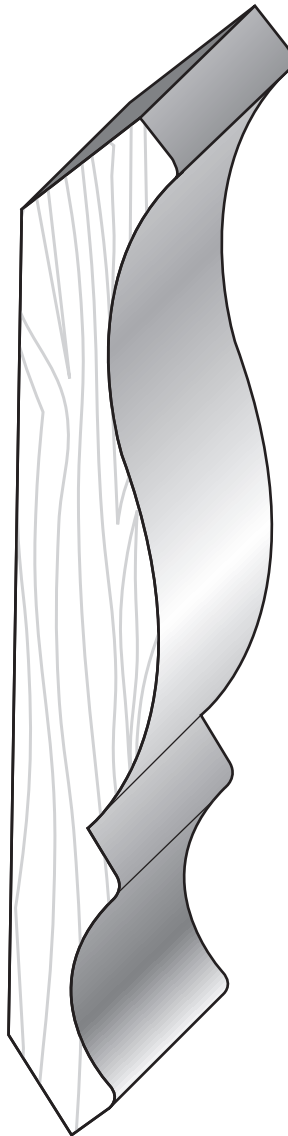

#111 $\frac{3}{4} \times 5\frac{3}{8}$

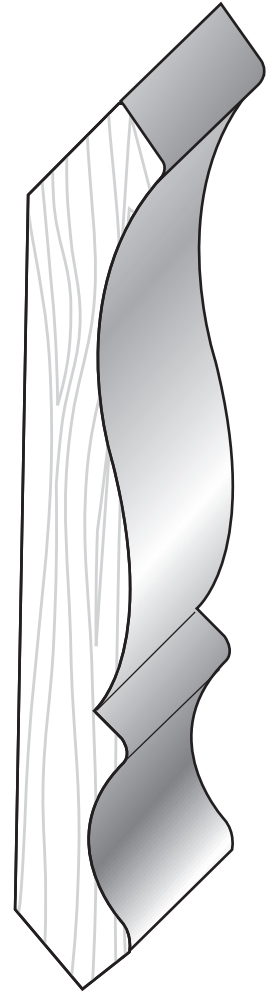

#102 $1\frac{1}{16} \times 4\frac{1}{2}$

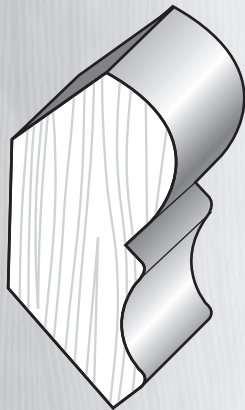

#08 $\frac{13}{16} \times 1\frac{3}{4}$

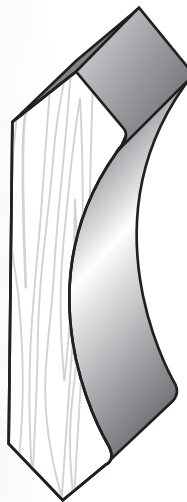

#113 $\frac{9}{16} \times 2\frac{1}{4}$

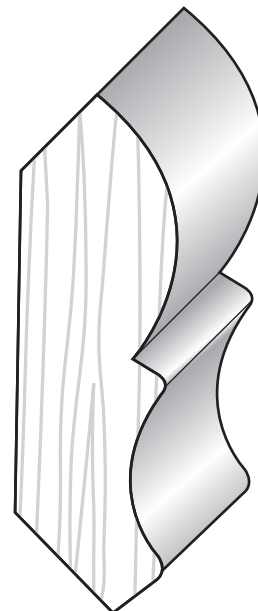

#116 $\frac{13}{16} \times 2\frac{3}{4}$



Smokey Mountain Lumber
INCORPORATED

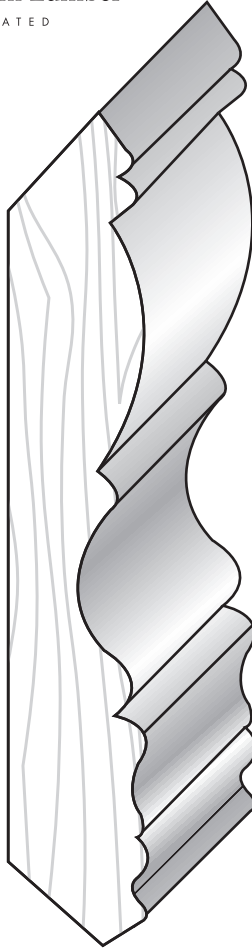

#104 $1\frac{1}{16} \times 4\frac{3}{8}$

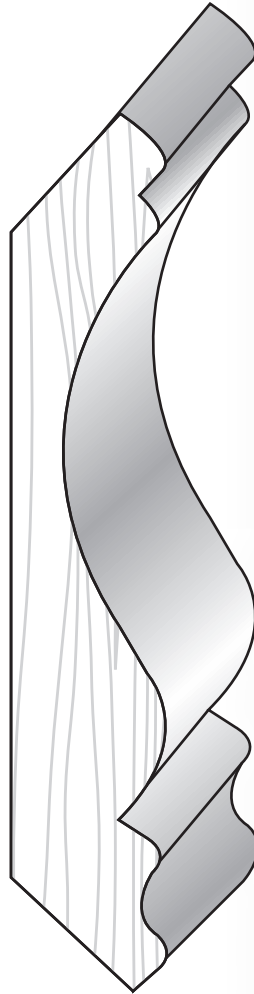

#112 $1\frac{3}{16} \times 4\frac{9}{16}$



#117 $1\frac{3}{16} \times 4\frac{5}{16}$

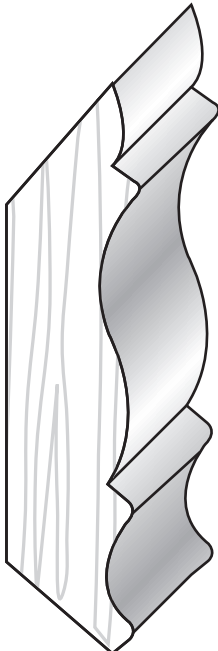

#108 $1\frac{1}{16} \times 3$

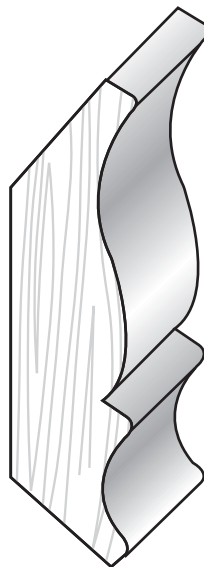

#109 $1\frac{1}{16} \times 2\frac{5}{8}$



#118 $\frac{9}{16} \times 3\frac{1}{8}$

CROWN

Smokey Mountain Lumber, Inc.

828.298.3958

CROWN

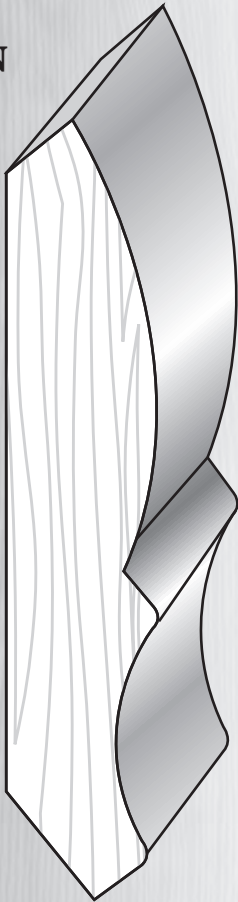

#119 $\frac{3}{4} \times 4\frac{1}{8}$

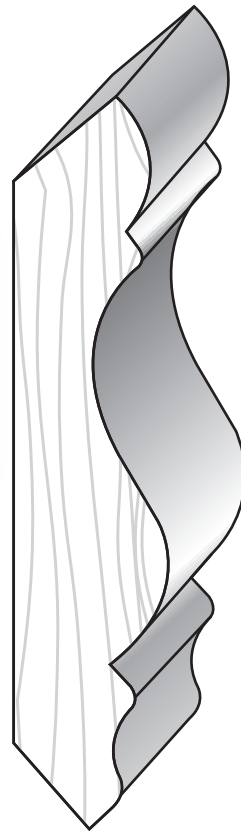

#115 $\frac{3}{4} \times 3\frac{7}{8}$

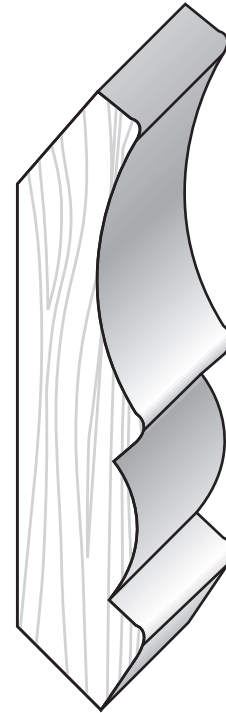

#105 $1\frac{1}{16} \times 3\frac{1}{4}$

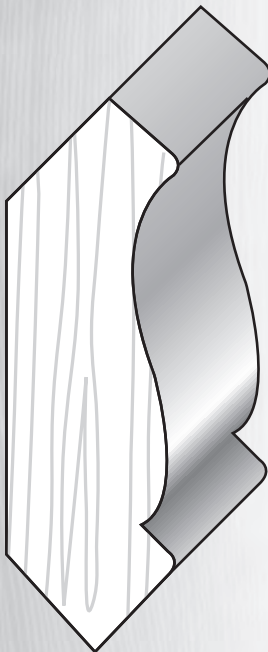

#120 $\frac{7}{8} \times 2\frac{15}{16}$

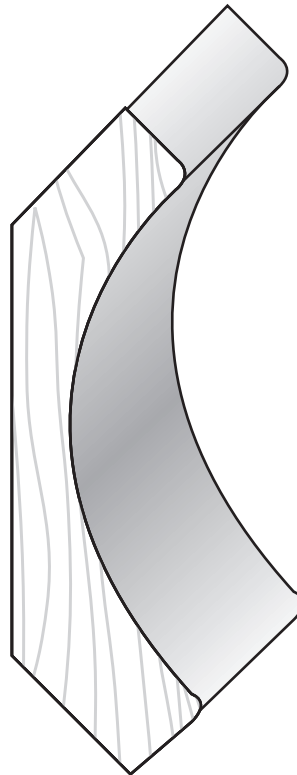

#114 $1\frac{5}{16} \times 3\frac{1}{2}$

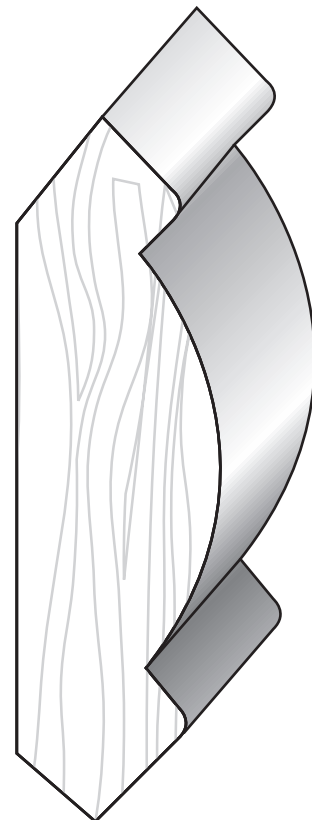

#106 $1\frac{1}{16} \times 3\frac{3}{4}$



Smokey Mountain Lumber
INCORPORATED

CROWN

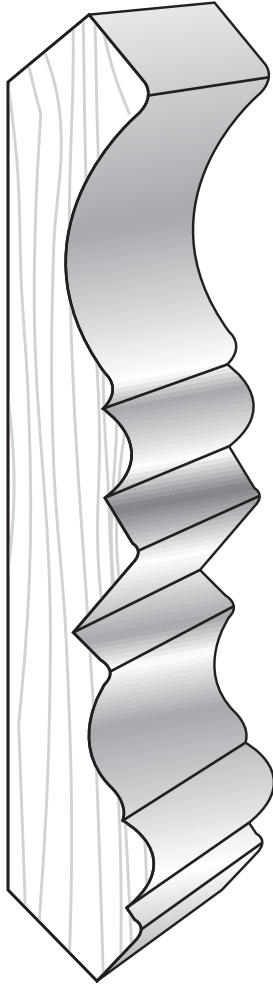

#121 $3/4 \times 5^{1/16}$

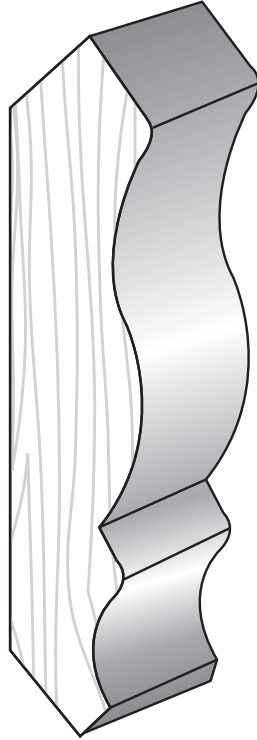

#122 $3/4 \times 3^{11/16}$

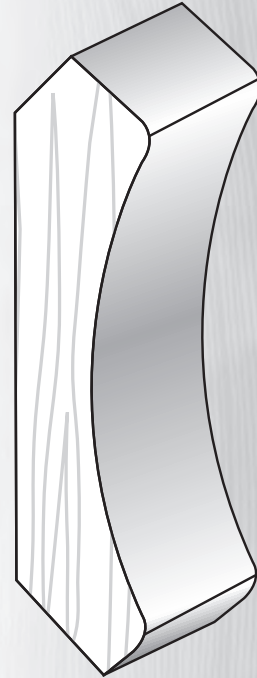

#123 $1^{1/16} \times 3^{1/4}$

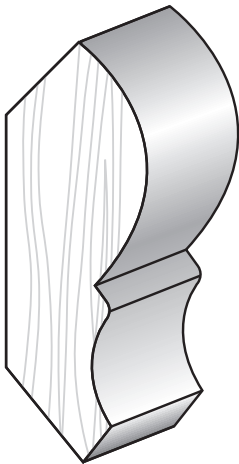

#124 $1^{1/16} \times 2^{3/8}$

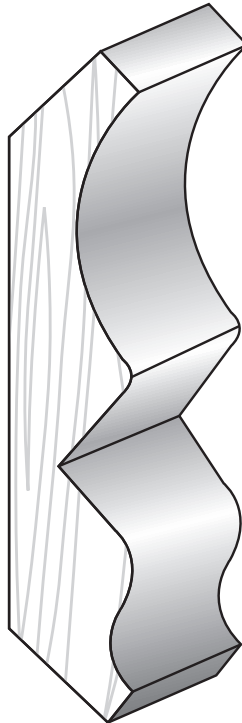

#125 $5/8 \times 3^{1/2}$



#126 $7/8 \times 4^{7/16}$

Smokey Mountain Lumber, Inc.

828.298.3958

CROWN

Smokey Mountain Lumber, Inc.

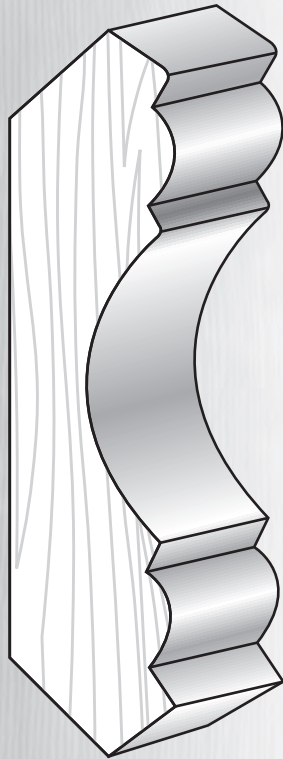

#131 $1\frac{3}{16} \times 3\frac{13}{16}$

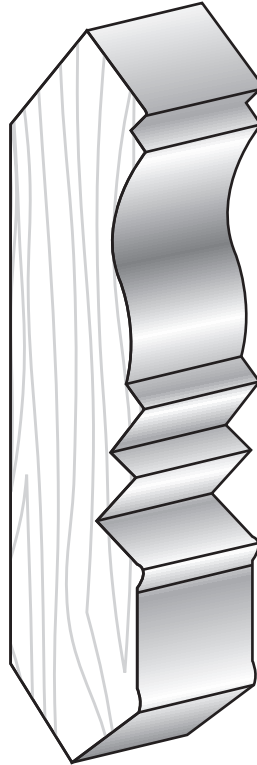

#132 $1\frac{11}{16} \times 3\frac{3}{4}$

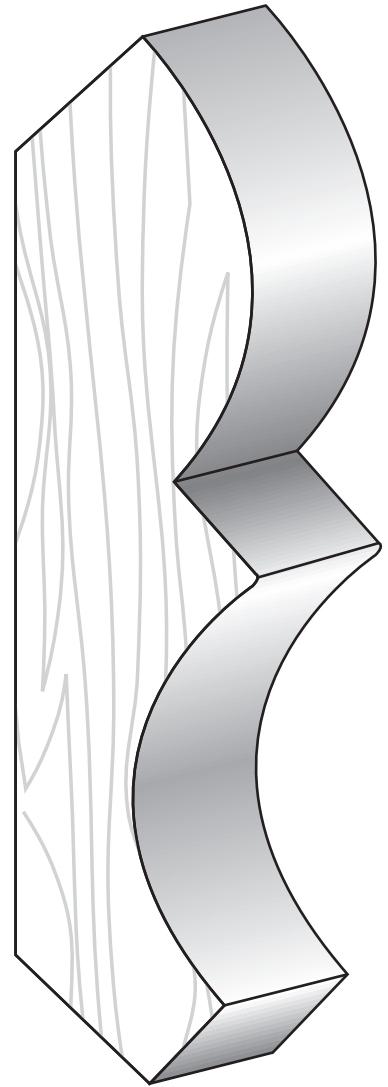

#133 $1\frac{1}{4} \times 5\frac{1}{2}$

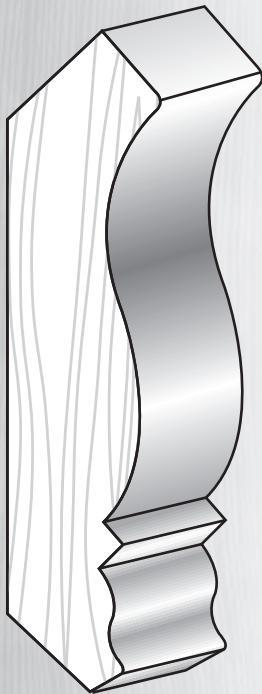

#134 $\frac{3}{4} \times 3\frac{1}{2}$

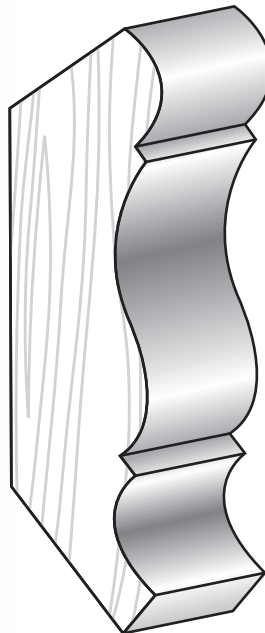

#135 $1\frac{3}{16} \times 3\frac{3}{16}$



CROWN

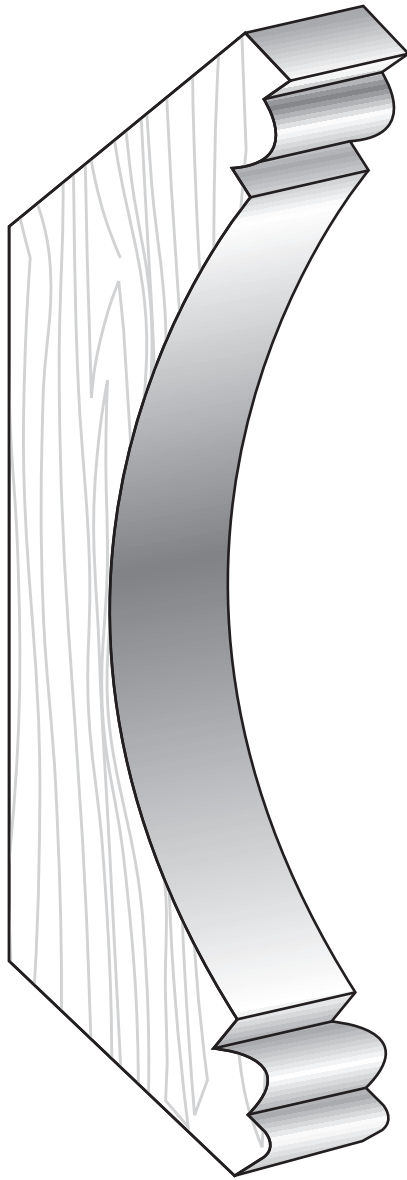

#136 1¹/₄ x 6

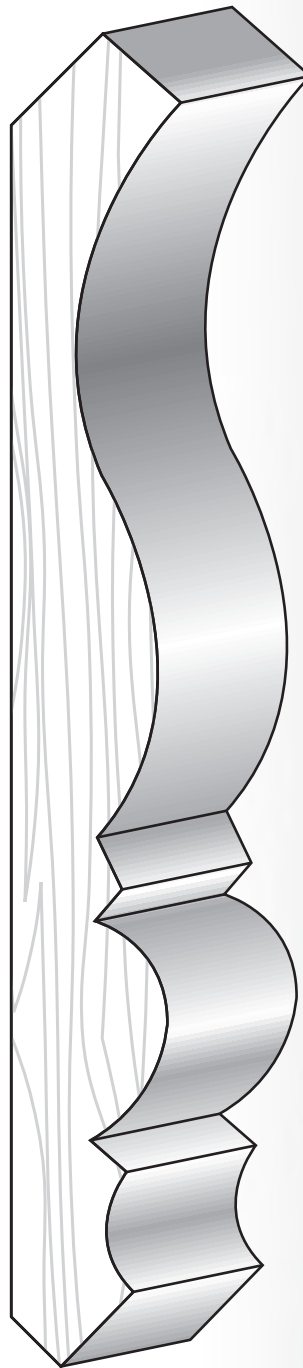

#138 1³/₁₆ x 7

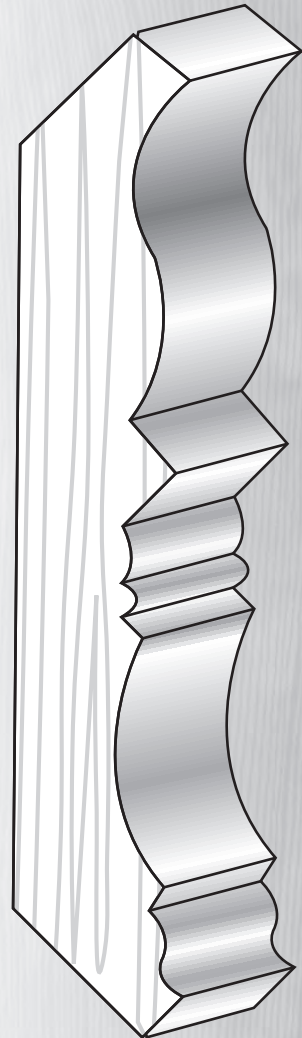

#137 1³/₁₆ x 5¹/₄

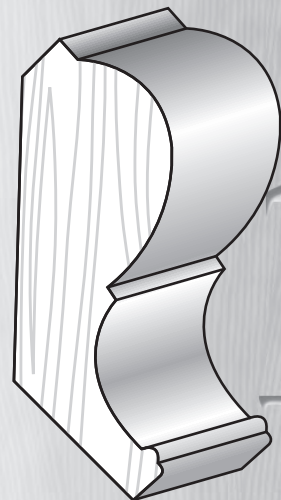

#139 3³/₄ x 2¹/₂

Smokey Mountain Lumber, Inc.

CROWN



#140 $\frac{3}{4} \times 4\frac{7}{16}$

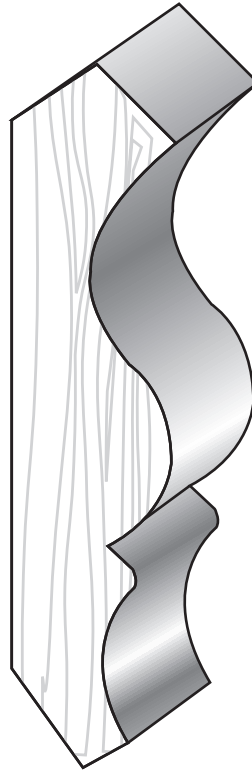

#141 $\frac{13}{16} \times 3\frac{5}{8}$

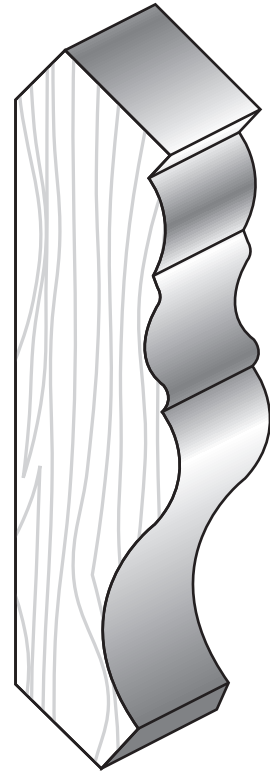

#142 $\frac{7}{8} \times 3\frac{11}{16}$

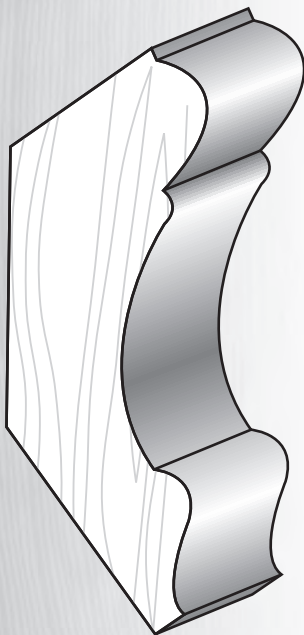

#143 1 x 3

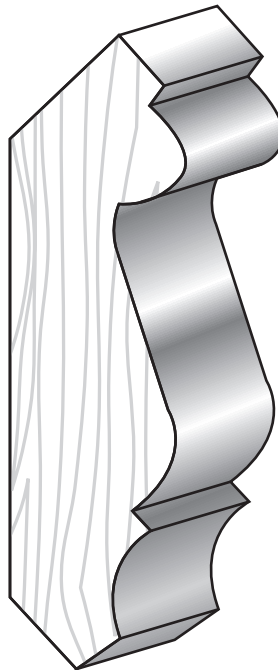

#144 $\frac{7}{8} \times 3\frac{1}{4}$



#145 $\frac{13}{16} \times 3\frac{3}{8}$



Smokey Mountain Lumber
INCORPORATED

CROWN

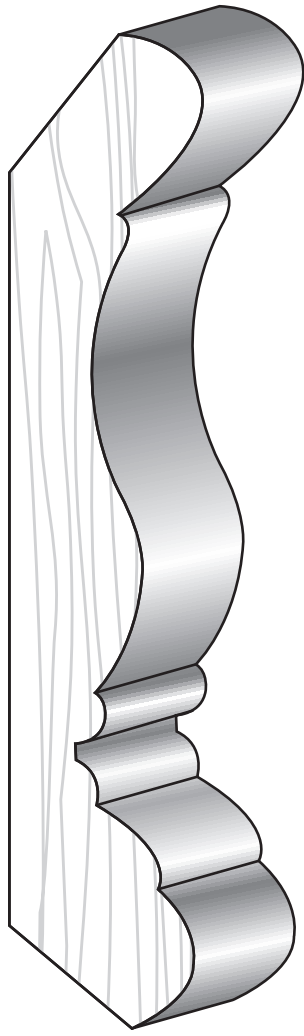

#149 1 x 5¹/₄

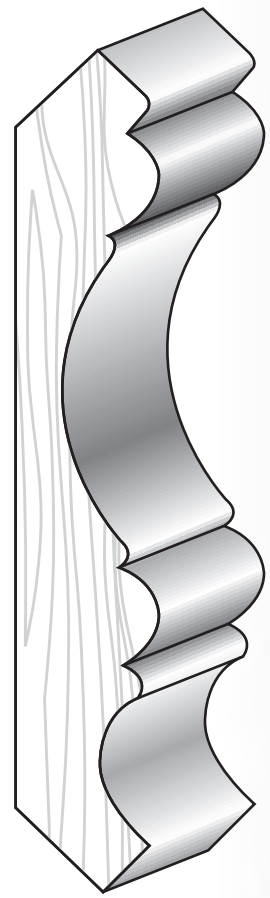

#150 3/4 x 4⁷/₁₆

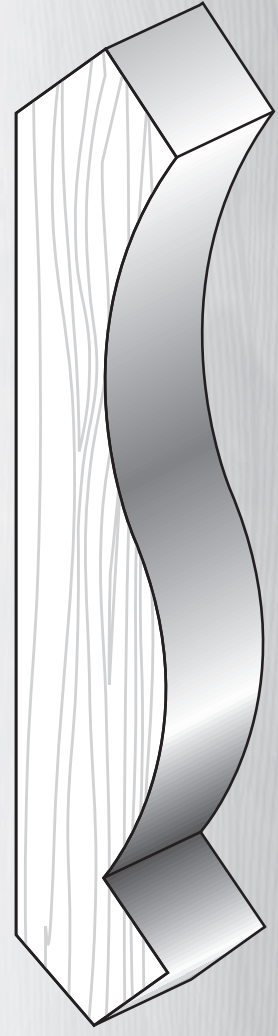

#151 1³/₁₆ x 5¹/₈

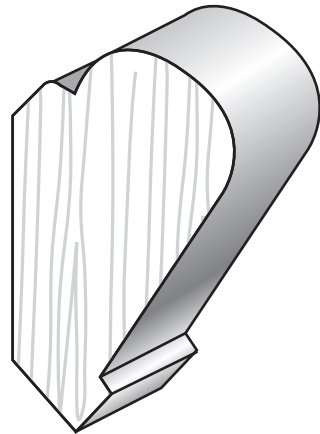

#152 1¹/₈ x 2

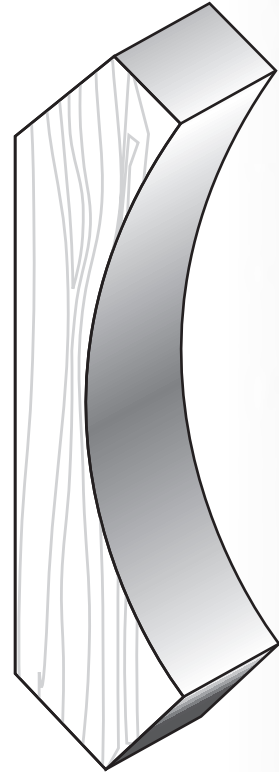

#153 1³/₁₆ x 3³/₄

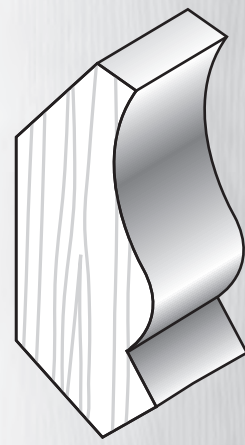

#154 1¹/₁₆ x 2

Smokey Mountain Lumber, Inc.

828.298.3958

CROWN

Smokey Mountain Lumber, Inc.

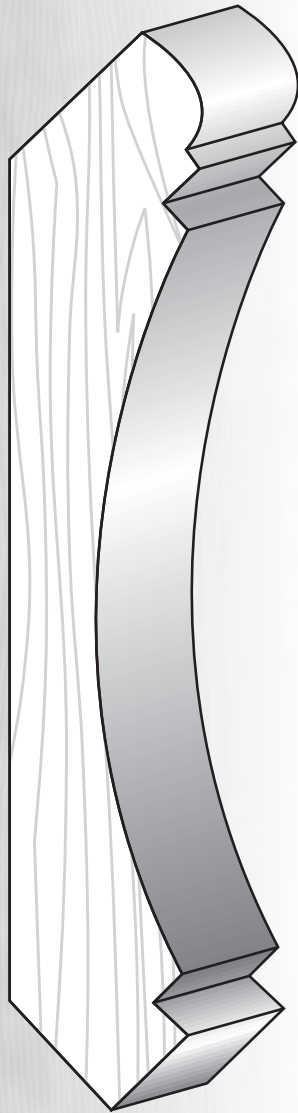

#146 1 x 5⁷/₈

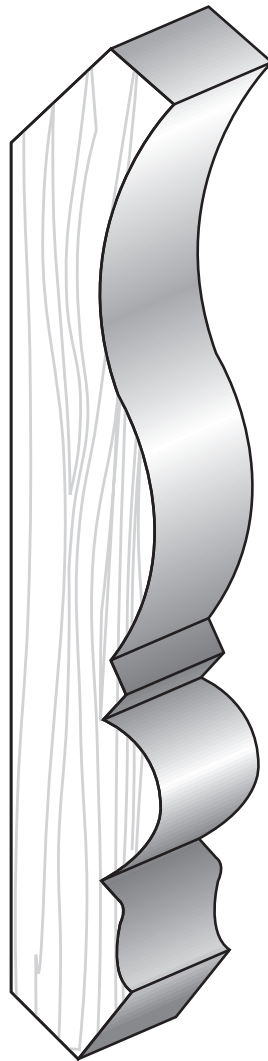

#147 1³/₁₆ x 5¹/₂

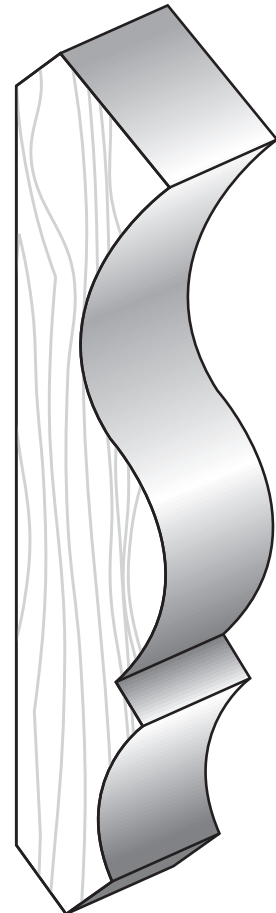

#148 1³/₁₆ x 4¹¹/₁₆



Smokey Mountain Lumber
INCORPORATED

CROWN

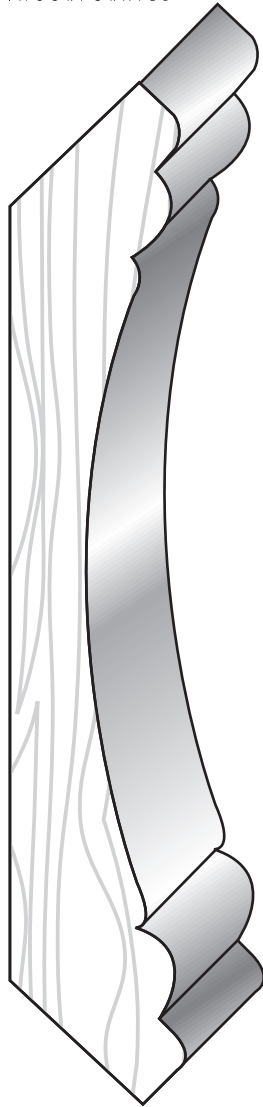

#155 $7/8 \times 5 1/4$

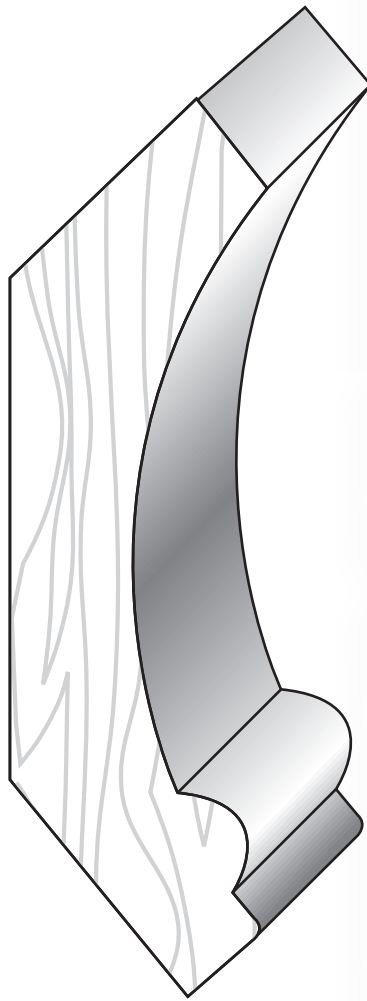

#156 $1 5/16 \times 4 5/8$

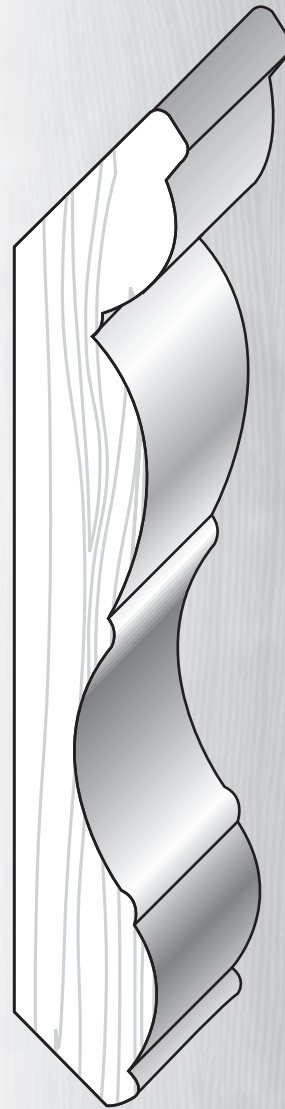

#157 $7/8 \times 5 1/8$

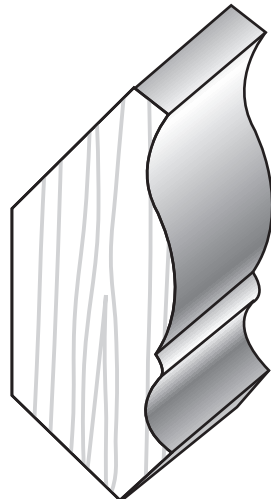

#158 $1 3/16 \times 2 1/8$

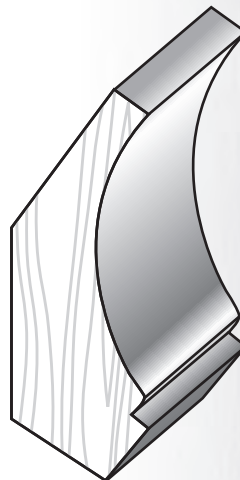

#159 $1 1/16 \times 2$

Smokey Mountain Lumber, Inc.

828.298.3958

CROWN

Smokey Mountain Lumber, Inc.

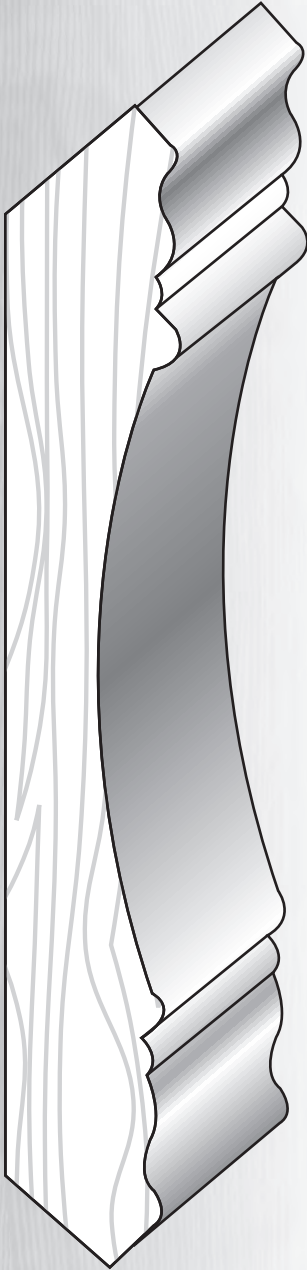

#160 $\frac{7}{8} \times 6$

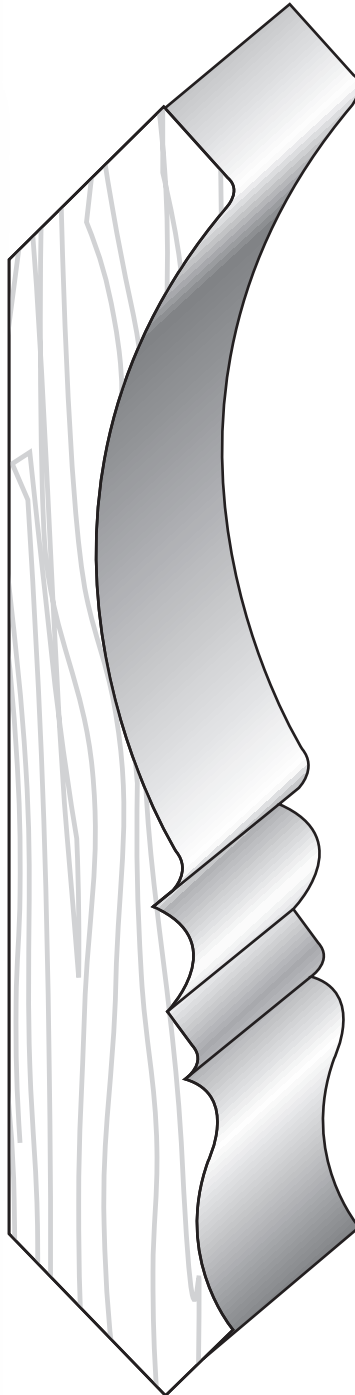

#161 $1\frac{3}{16} \times 6\frac{3}{4}$

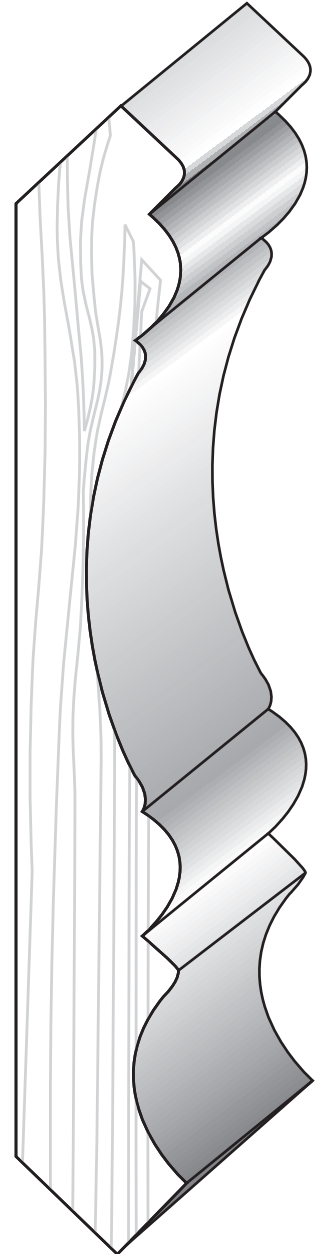

#162 $\frac{7}{8} \times 6$



Smokey Mountain Lumber
INCORPORATED

CROWN

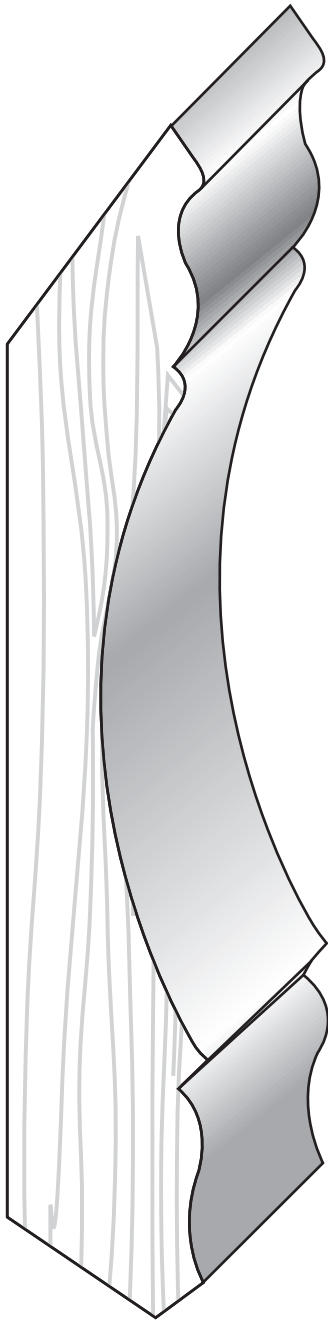

#163 1 x 6³/₄

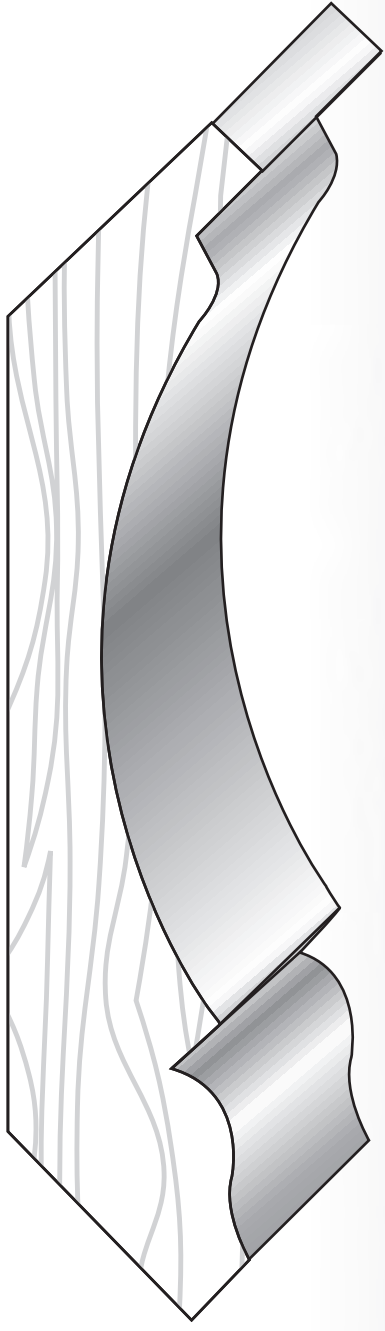

#164 1¹/₄ x 6¹/₄

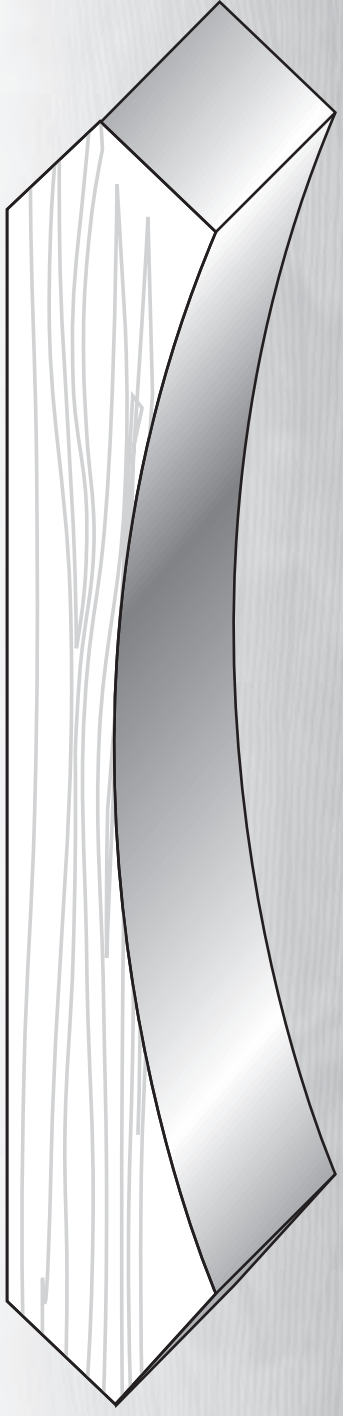

#165 1¹/₁₆ x 6³/₄

Smokey Mountain Lumber, Inc.

CROWN

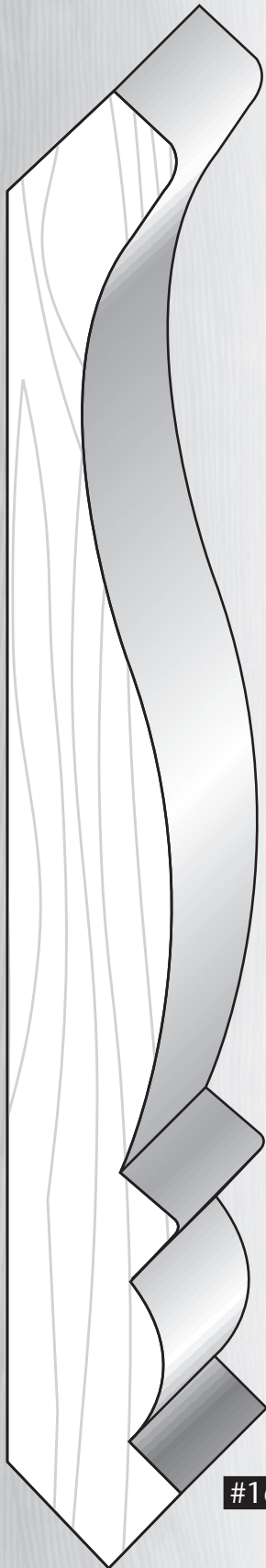

#166 1 x 8³/₈

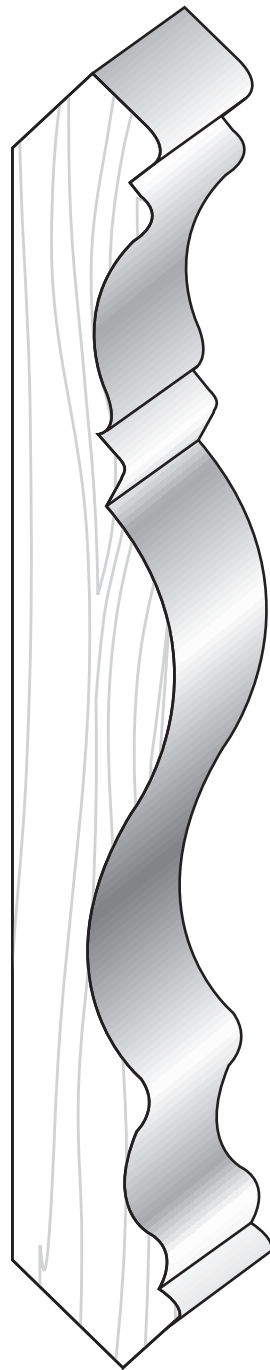

#167 1³/₁₆ x 6³/₄

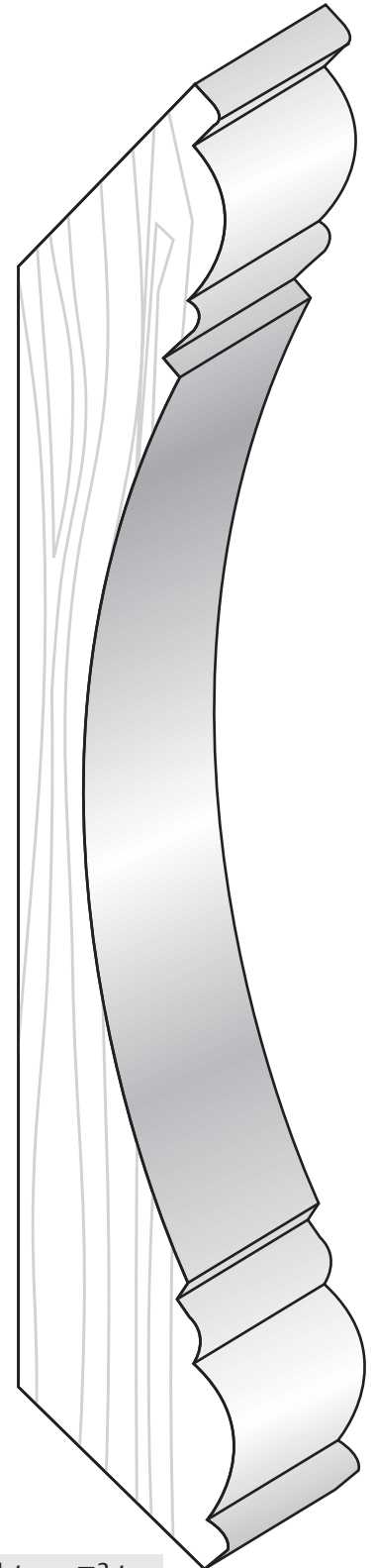

#168 1¹/₈ x 7³/₄



Smokey Mountain Lumber
INCORPORATED

CASING

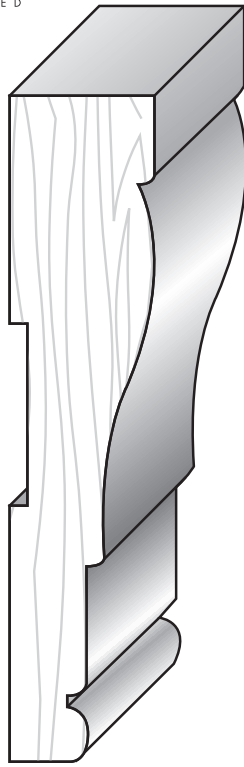

#200 $3/4 \times 3^{11}/16$

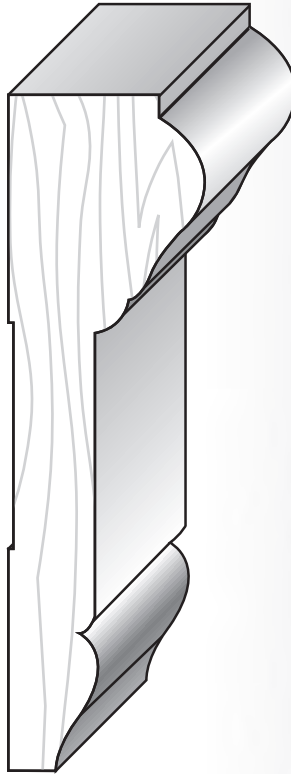

#208 $1^{1}/16 \times 3^{11}/16$



#201 $1^{5}/16 \times 3^{11}/16$

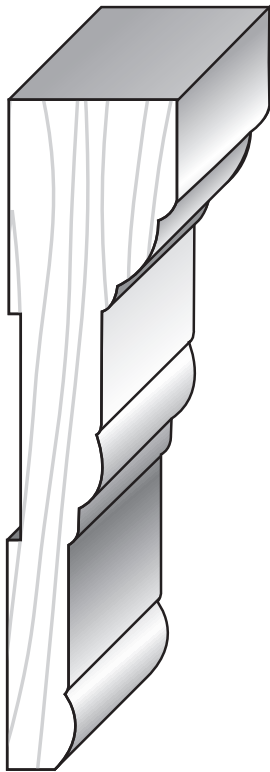

#203 $1^{5}/16 \times 3^{11}/16$

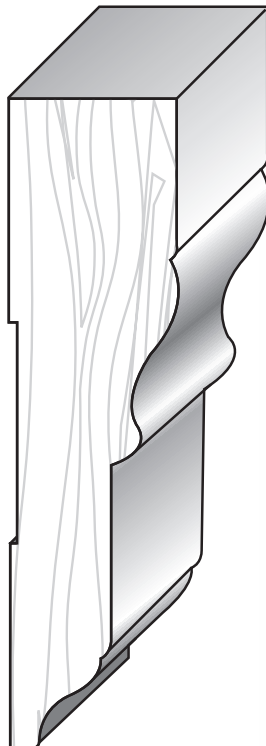

#202 $1^{5}/16 \times 3^{9}/16$

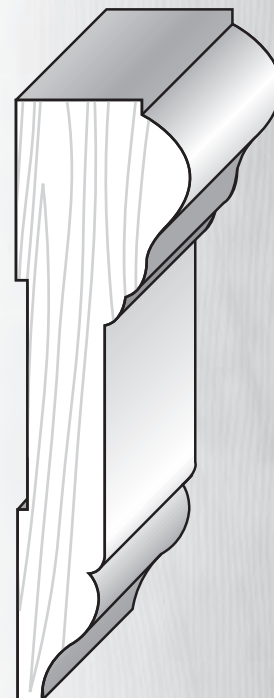

#217 $1^{5}/16 \times 3^{1}/4$

Smokey Mountain Lumber, Inc.

828.298.3958

Smokey Mountain Lumber, Inc.

CASING

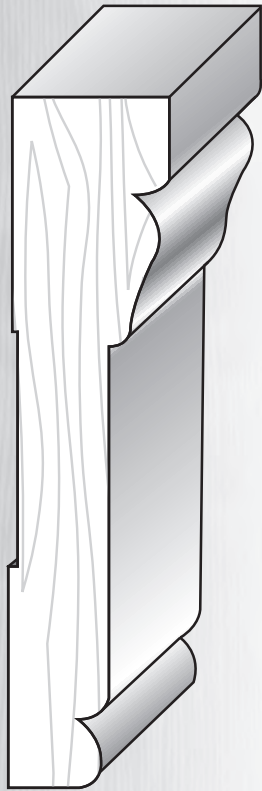

#204 $1\frac{3}{16} \times 3\frac{3}{4}$

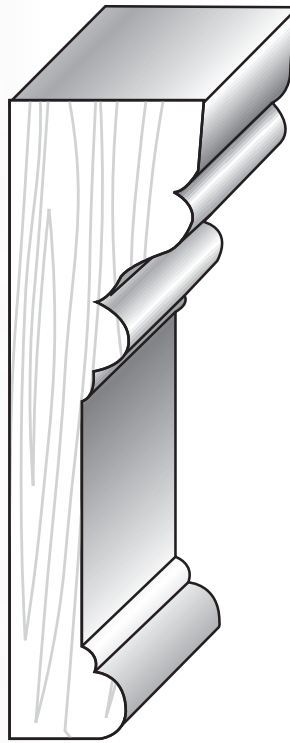

#205 $1 \times 3\frac{1}{2}$

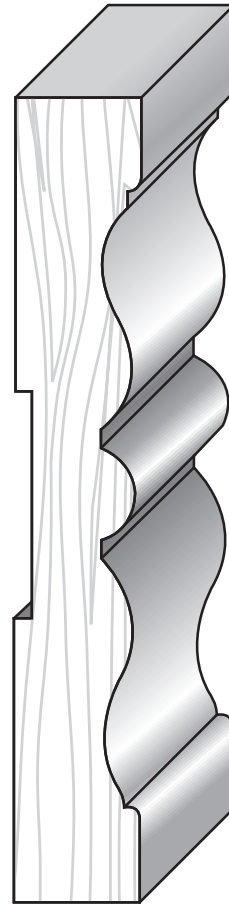

#209 $1\frac{1}{16} \times 4\frac{5}{16}$



#211 $1\frac{3}{16} \times 3\frac{1}{2}$

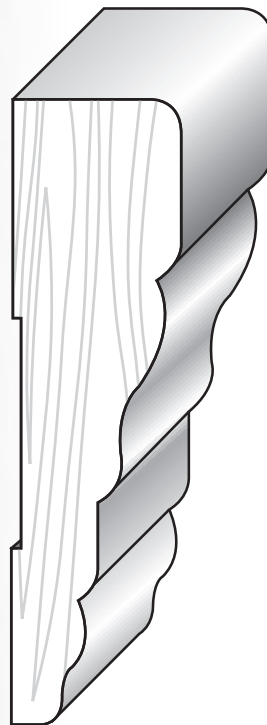

#218 $\frac{7}{8} \times 3\frac{3}{8}$

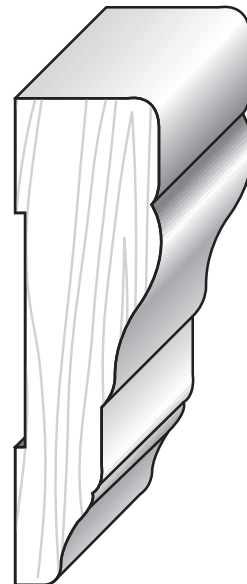

#219 $1\frac{3}{16} \times 2\frac{5}{8}$



Smokey Mountain Lumber
INCORPORATED

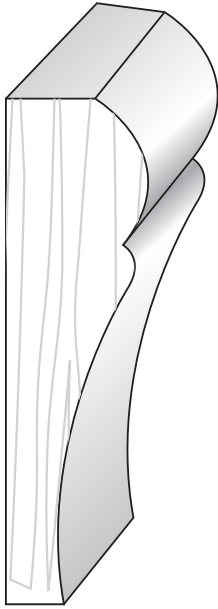

#207 $3/4 \times 2^{5/8}$

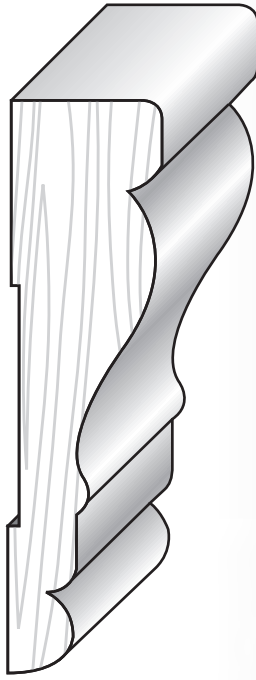

#213 $3/4 \times 3$

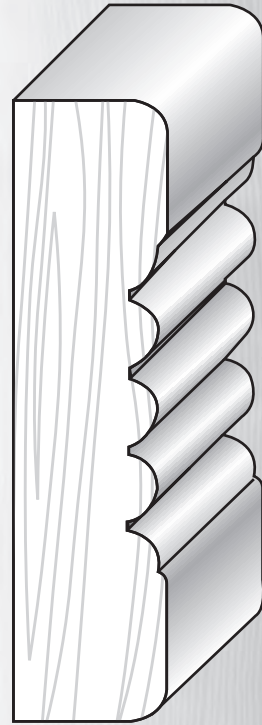

#212 $3/4 \times 3^{1/4}$

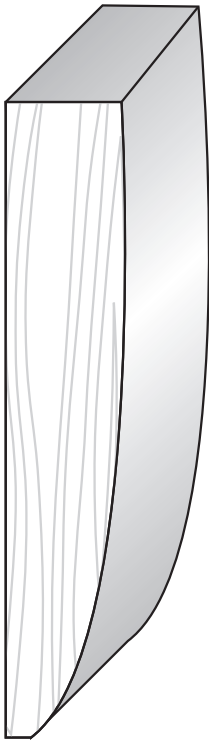

#221 $9/16 \times 3^{5/16}$

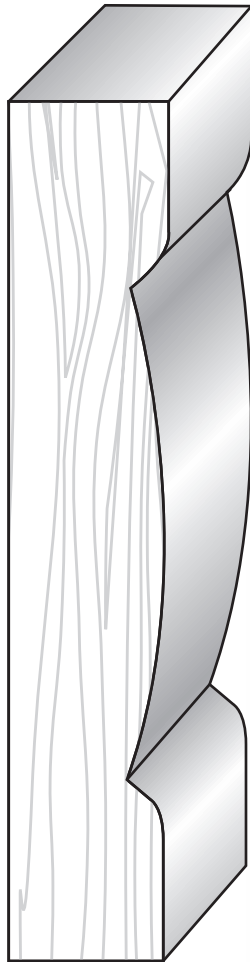

#220 $3/4 \times 4^{1/2}$

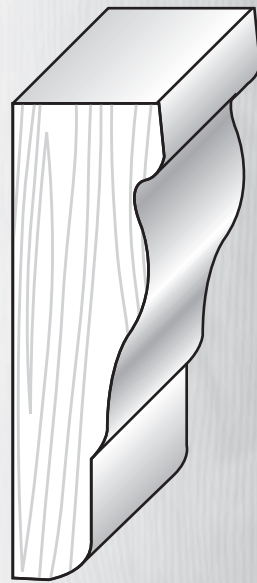

#222 $3/4 \times 2^{1/2}$

CASING

Smokey Mountain Lumber, Inc.

828.298.3958

CASING

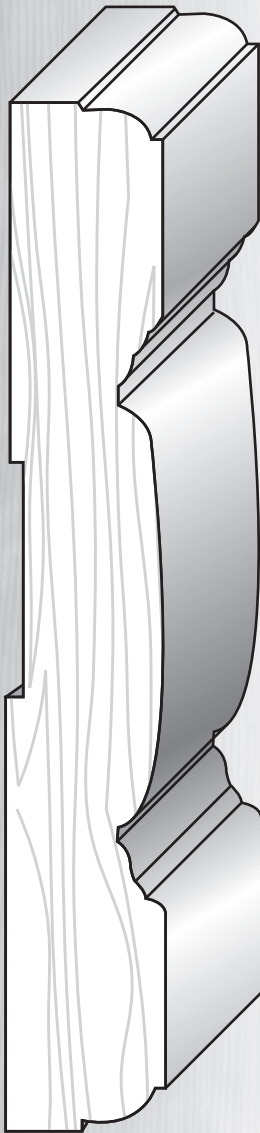

#223 $1\frac{3}{16} \times 5\frac{3}{8}$

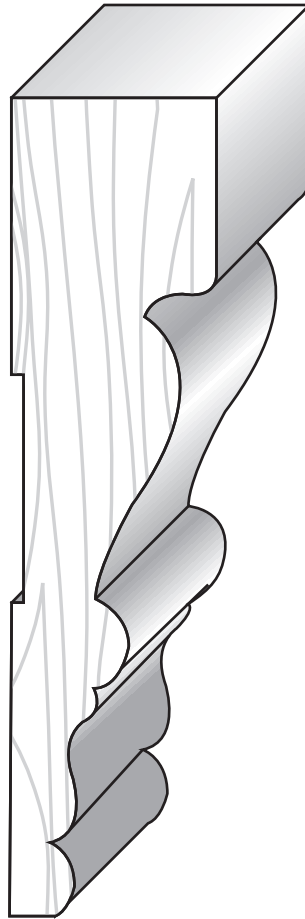

#214 $1\frac{1}{16} \times 4\frac{5}{16}$

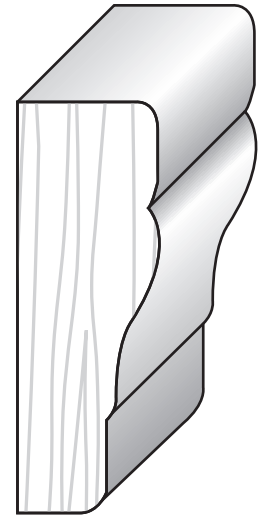

#216 $\frac{3}{4} \times 2\frac{1}{8}$

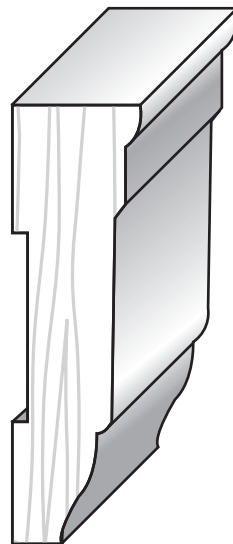

#224 $\frac{5}{8} \times 2\frac{1}{4}$

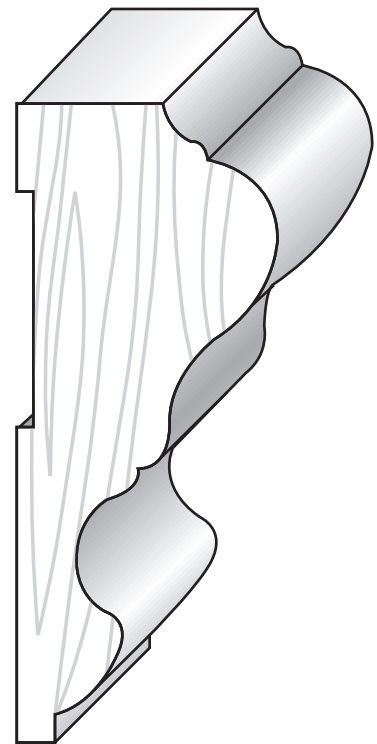

#215 $1\frac{3}{8} \times 3\frac{3}{8}$



Smokey Mountain Lumber
INCORPORATED

CASING

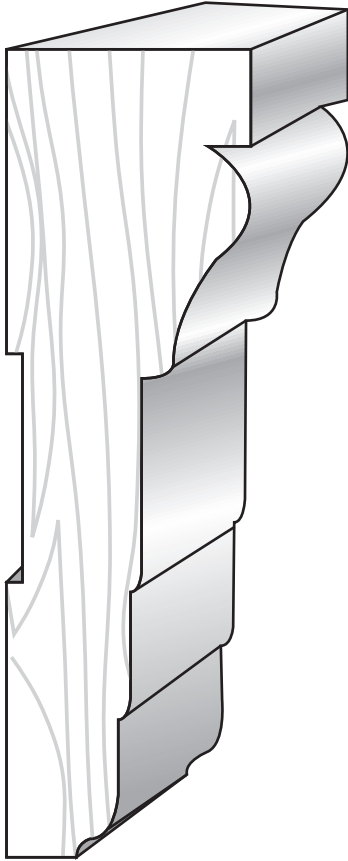

#228 1 1/4 x 4 1/4

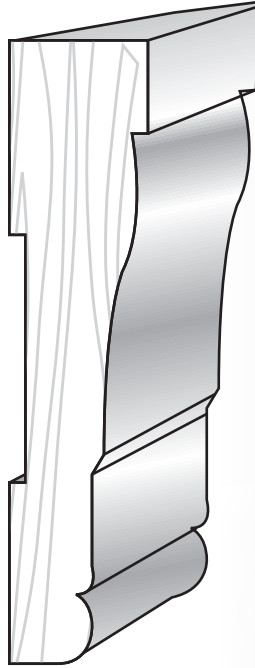

#229 1 1/16 x 3 1/4

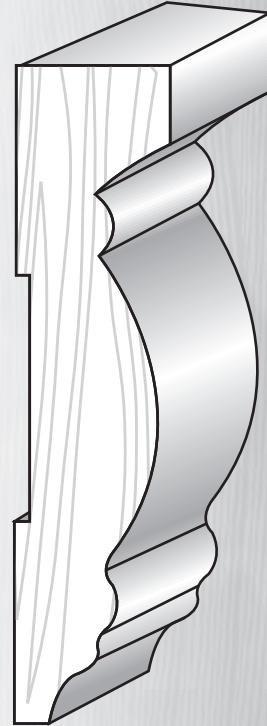

#227 3/4 x 3 1/2

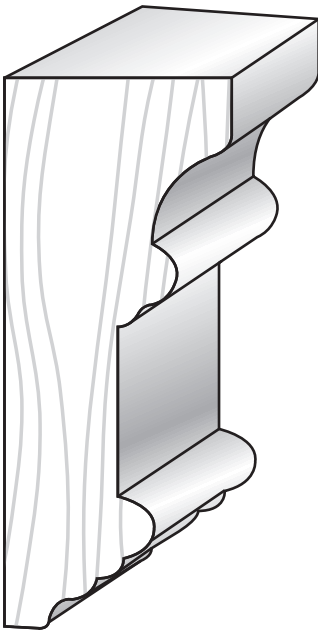

#230 1 1/8 x 2 7/8

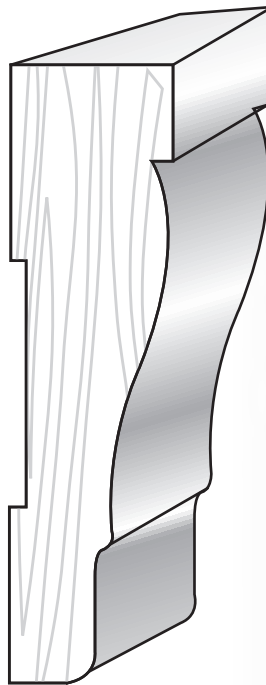

#231 3/4 x 3 1/4

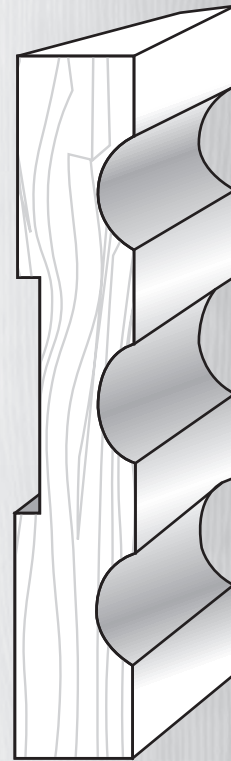

#226 5/8 x 3 3/4

Smokey Mountain Lumber, Inc.

828.298.3958

Smokey Mountain Lumber, Inc.

CASING

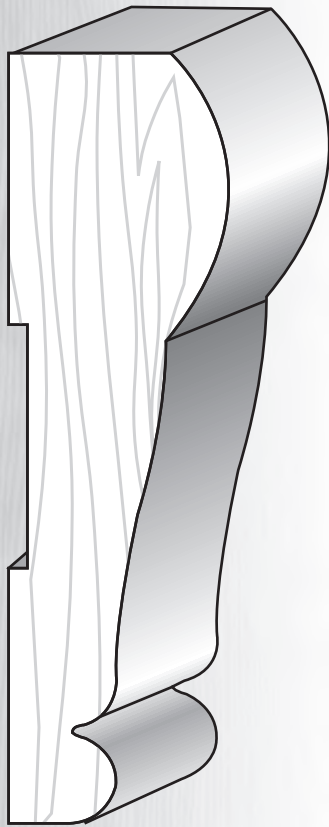

#232 1¹/₁₆ x 4

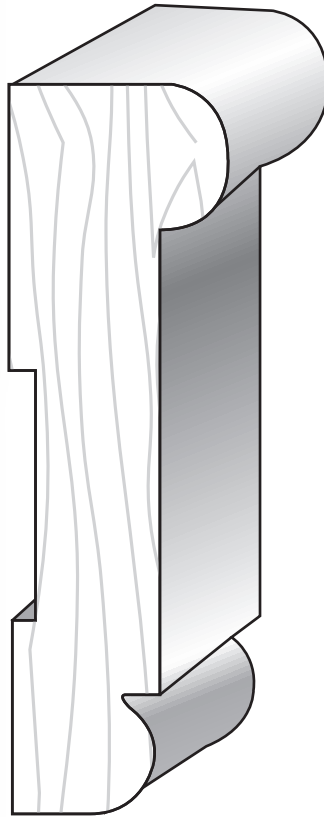

#233 1¹/₈ x 3³/₄

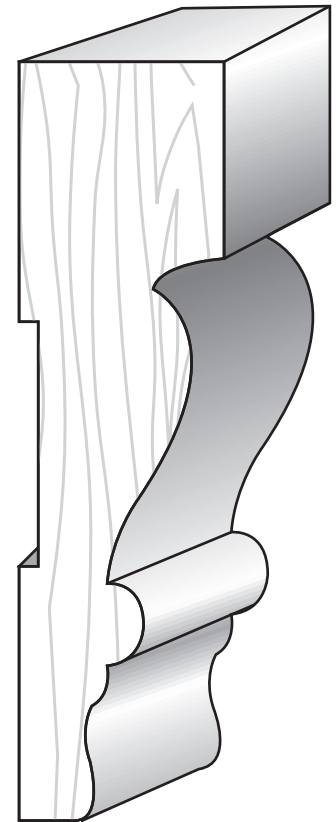

#234 1¹/₁₆ x 4



#235 1 x 2³/₄

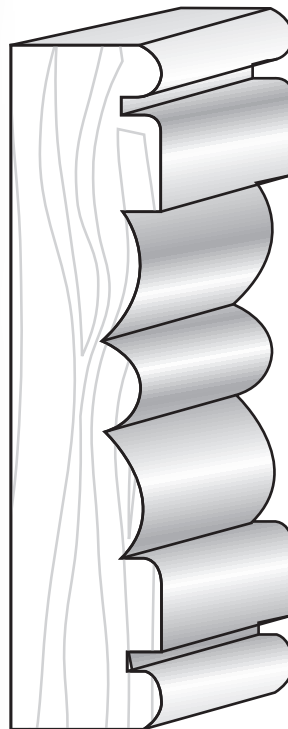

#236 3³/₄ x 3¹/₂

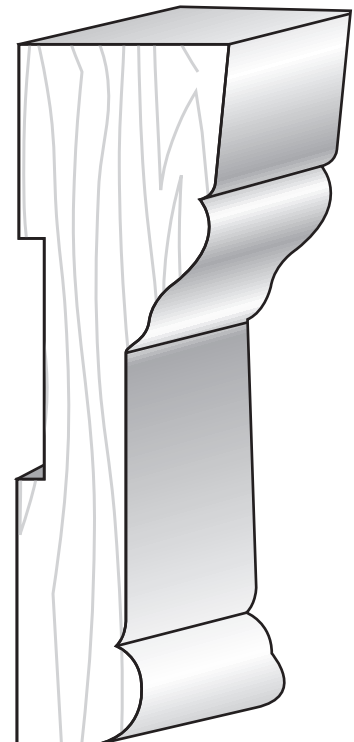

#237 1¹/₁₆ x 3⁵/₈



CASING

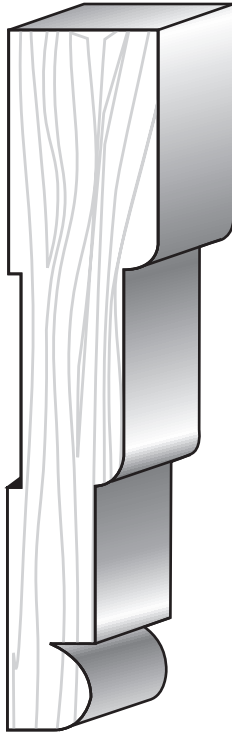

#238 $3/4 \times 3 3/4$

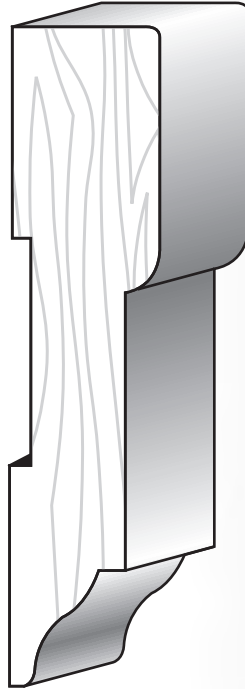

#239 $3/4 \times 3 1/2$

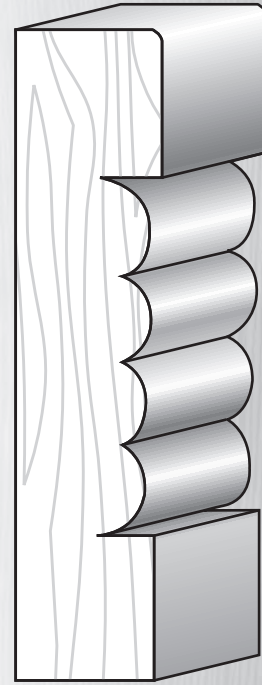

#240 $3/4 \times 3 1/2$

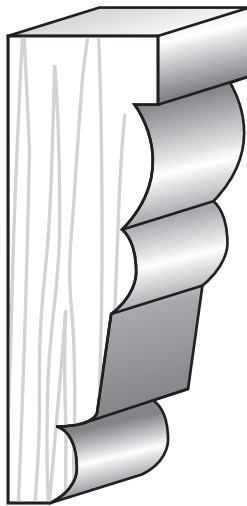

#241 $3/4 \times 2 1/2$



#242 $1 \times 3 5/16$



#243 $3/4 \times 3$

Smokey Mountain Lumber, Inc.

Smokey Mountain Lumber, Inc.

CASING



#244 $3/4 \times 3 1/4$

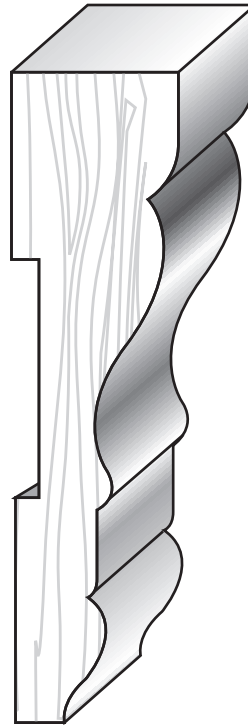

#245 $1 3/16 \times 3 1/2$

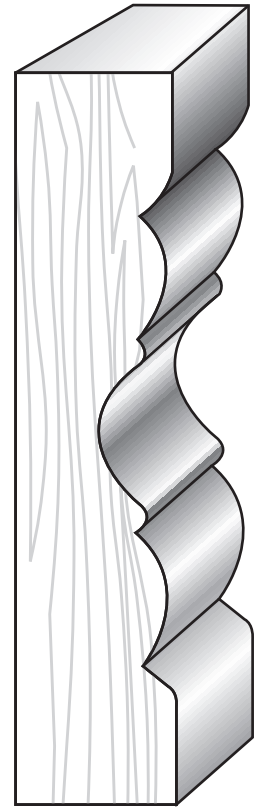

#246 $1 3/16 \times 3 7/8$

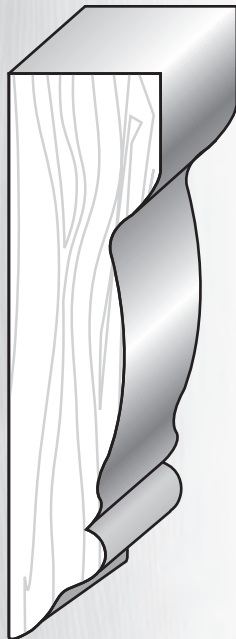

#247 $3/4 \times 3$

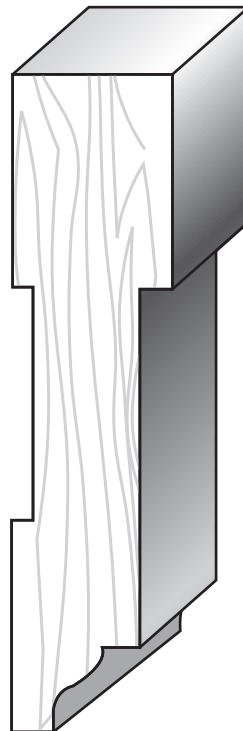

#248 $1 3/16 \times 3 1/2$

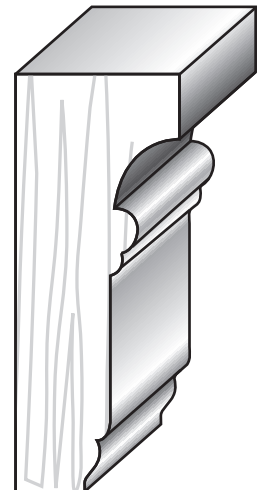

#249 $1 3/16 \times 2 1/4$



Smokey Mountain Lumber
INCORPORATED

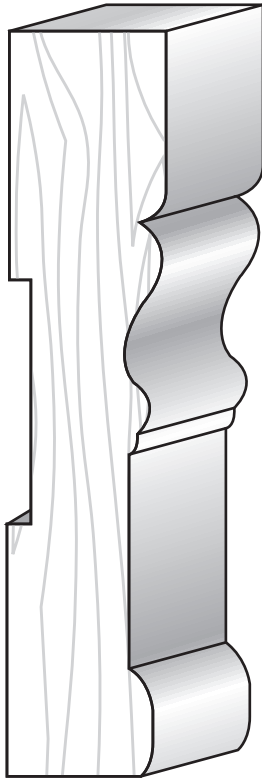

#250 1³/₁₆ x 3⁷/₈

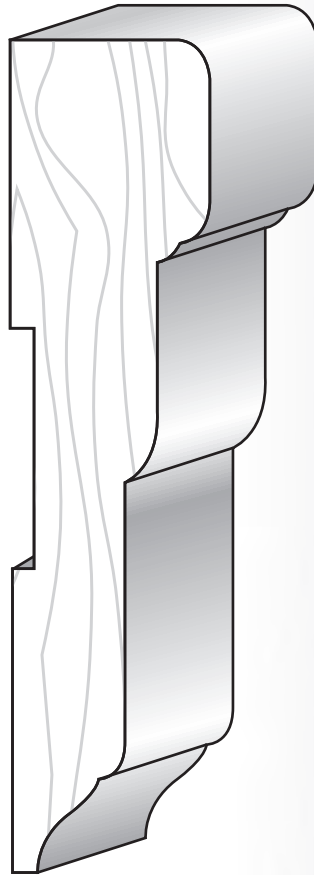

#251 1 x 4¹/₄



#252 3/4 x 3¹/₂

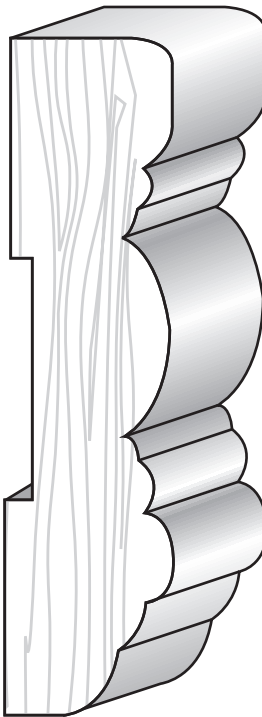

#253 1³/₁₆ x 3¹/₂

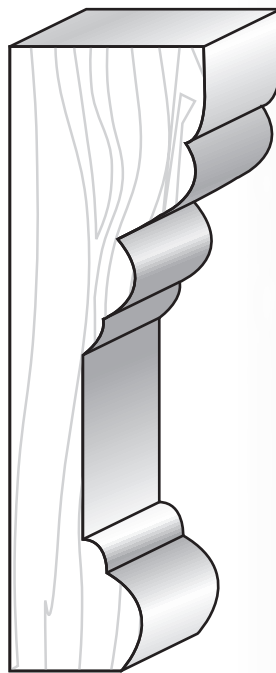

#254 1 x 3¹/₄

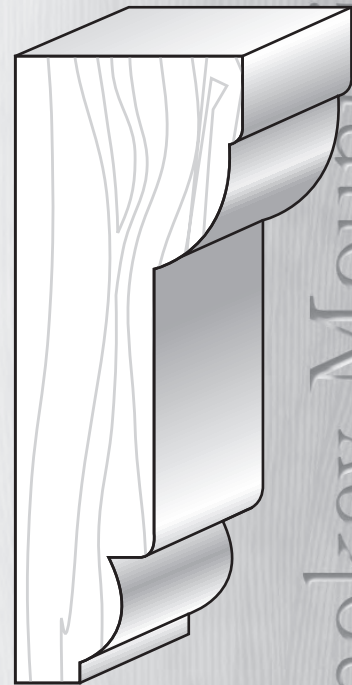

#255 1³/₁₆ x 3¹/₄

CASING

Smokey Mountain Lumber, Inc.

828.298.3958

CASING

Smokey Mountain Lumber, Inc.

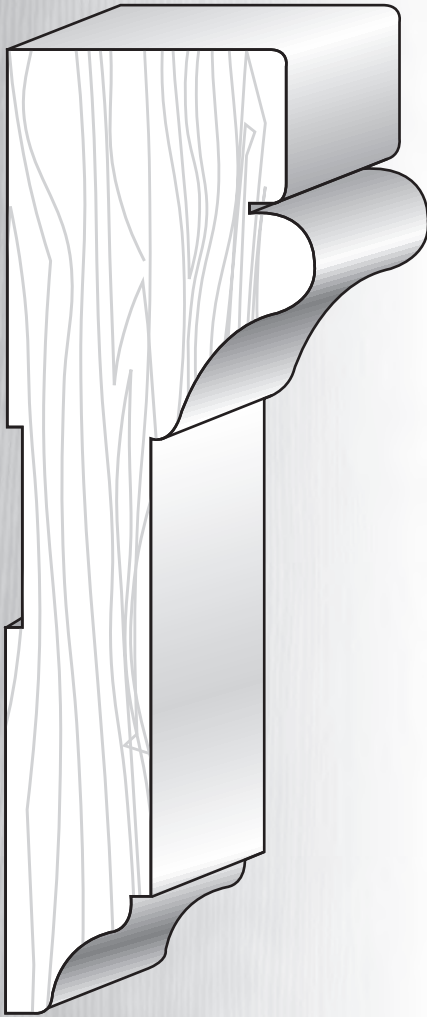

#256 $1\frac{9}{16} \times 5$

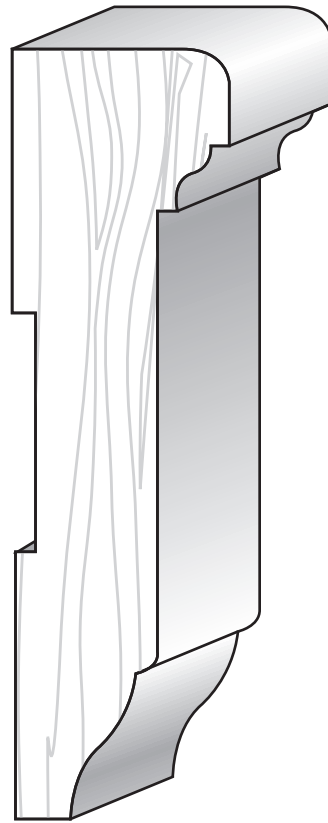

#257 $1\frac{1}{16} \times 4$

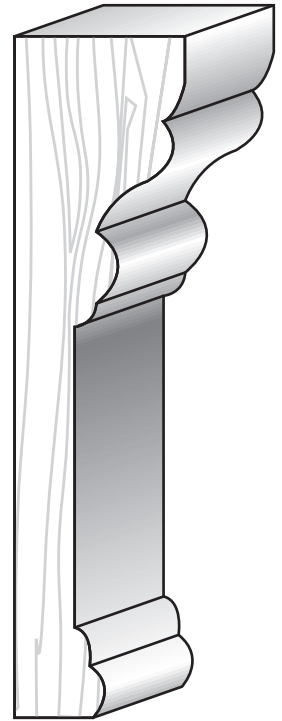

#258 $\frac{7}{8} \times 3\frac{1}{2}$

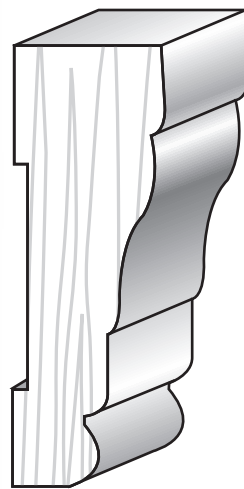

#259 $\frac{3}{4} \times 2\frac{1}{4}$

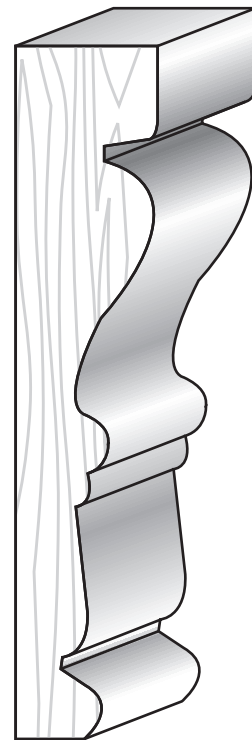

#260 $\frac{3}{4} \times 3\frac{5}{8}$



Smokey Mountain Lumber
INCORPORATED

CASING

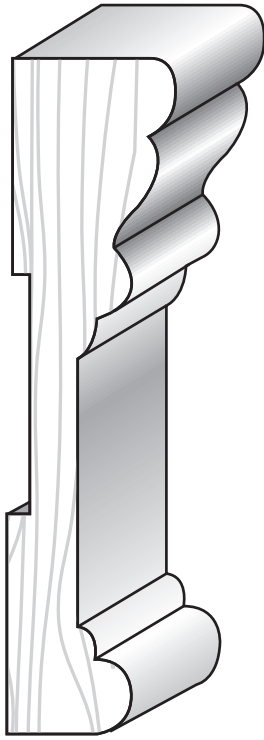

#266 $7/8 \times 3\frac{1}{2}$

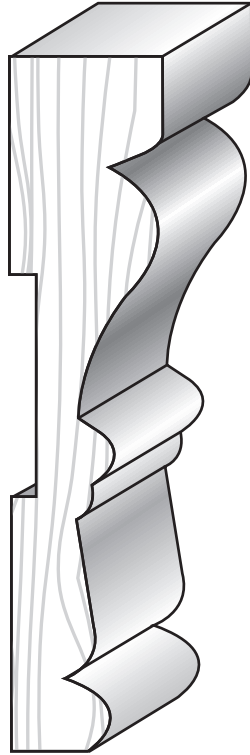

#265 $1\frac{3}{16} \times 3\frac{5}{8}$

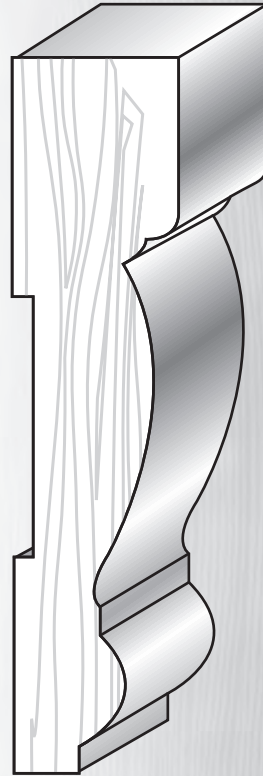

#264 $3/4 \times 3\frac{3}{4}$

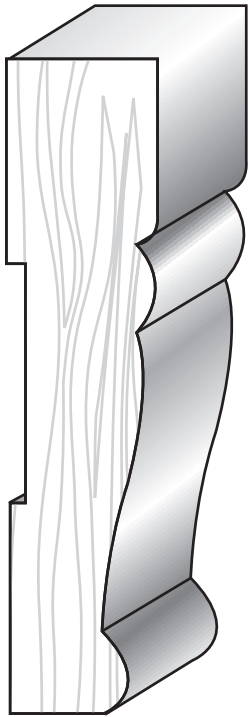

#263 $1\frac{3}{16} \times 3\frac{3}{8}$

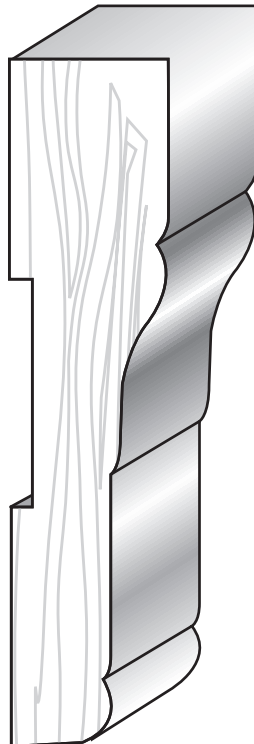

#262 $3/4 \times 3\frac{1}{2}$

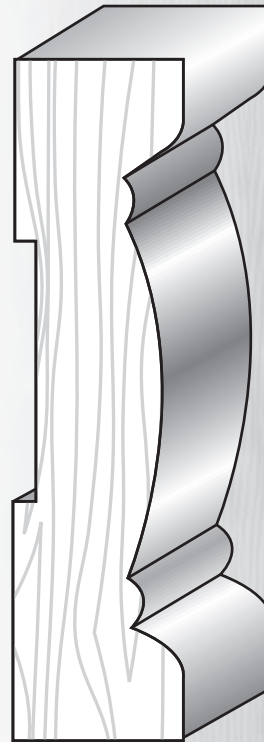

#261 $1\frac{3}{16} \times 3\frac{1}{2}$

Smokey Mountain Lumber, Inc.

BASEBOARD

Smokey Mountain Lumber, Inc.

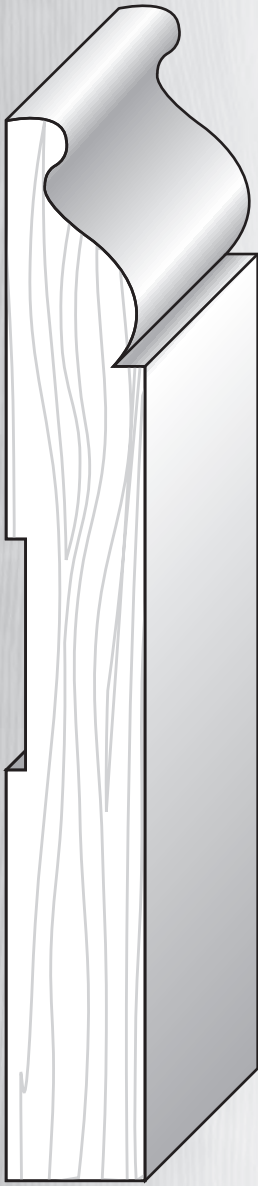

#300 $\frac{3}{4} \times 5\frac{1}{2}$

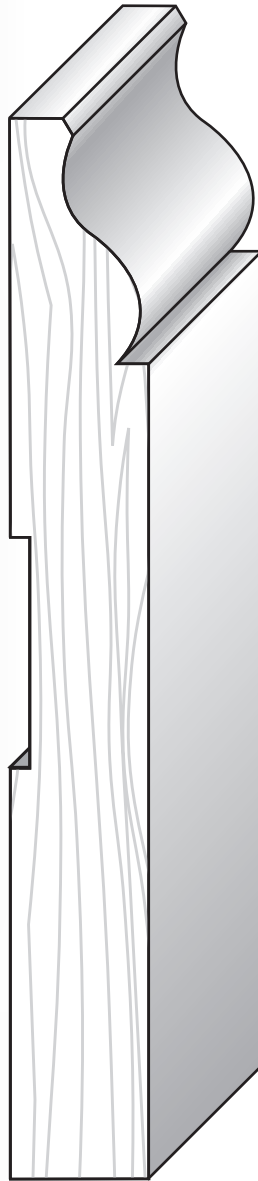

#302 $1\frac{1}{16} \times 5\frac{1}{2}$

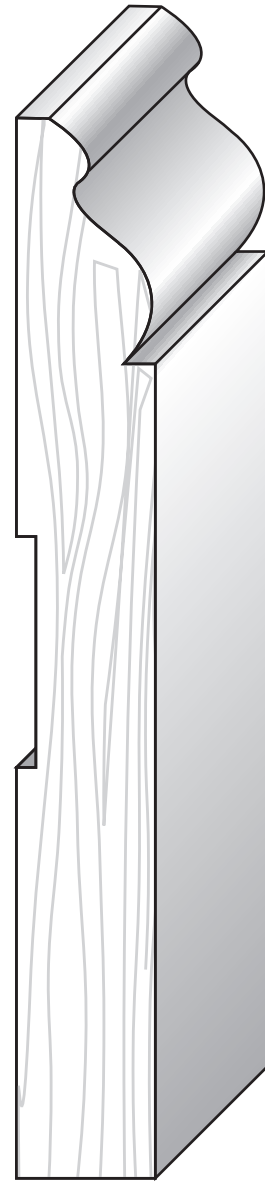

#309 $\frac{3}{4} \times 5\frac{1}{2}$



#500 $1\frac{1}{16} \times 1\frac{5}{16}$

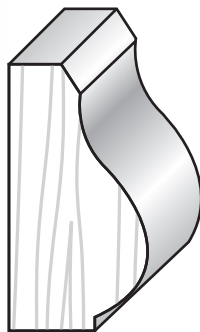

#502 $1\frac{1}{16} \times 1\frac{3}{8}$

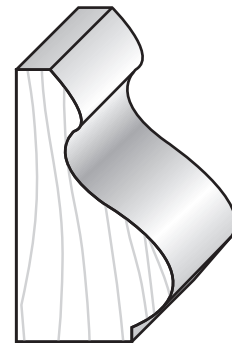

#509 $\frac{3}{4} \times 1\frac{3}{8}$

828.298.3958



Smokey Mountain Lumber
INCORPORATED

BASEBOARD

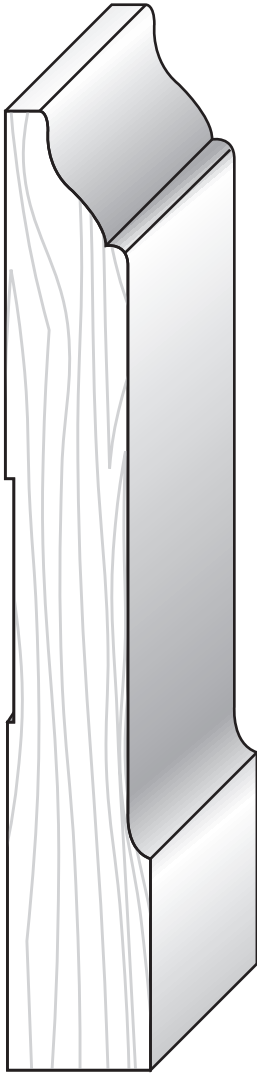

#311 $3/4 \times 5$

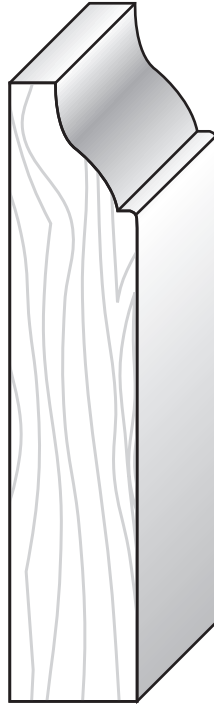

#312 $5/8 \times 3 1/4$

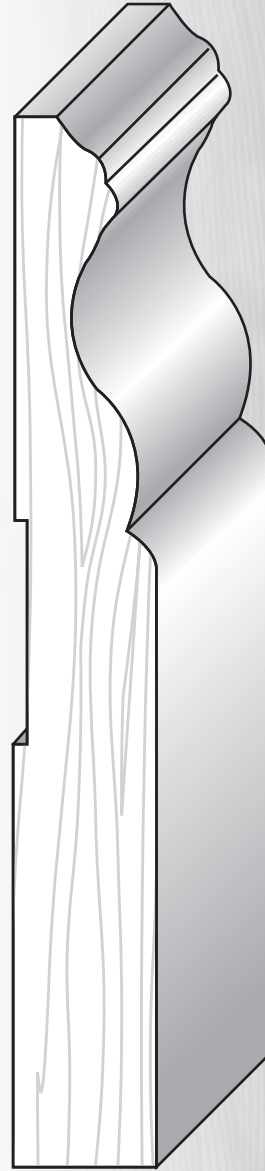

#306 $1 1/16 \times 5 1/2$

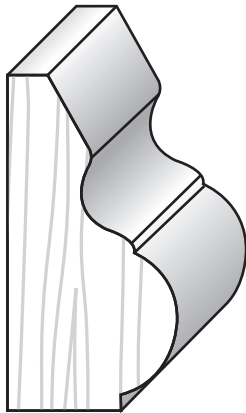

#503 $1 3/16 \times 1 3/4$

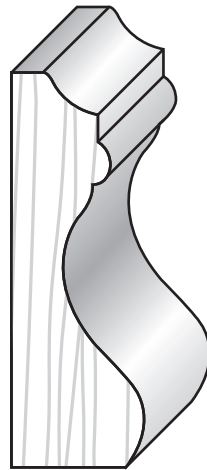

#506 $1 1/16 \times 2 1/16$

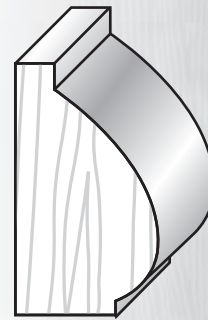

#504 $1 1/16 \times 1 5/16$

Smokey Mountain Lumber, Inc.

BASEBOARD

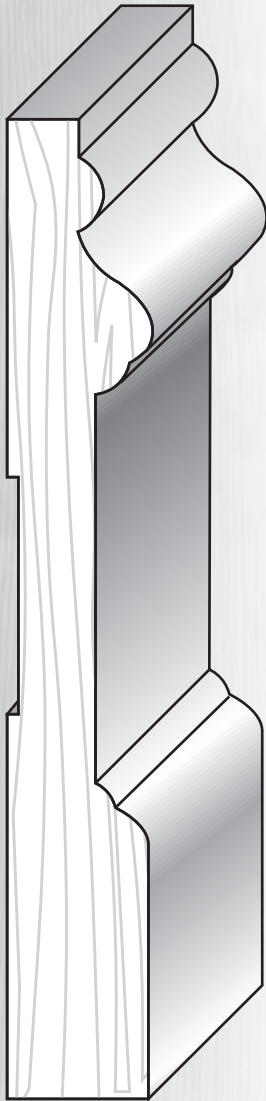

#310 $1\frac{1}{16} \times 5\frac{1}{8}$

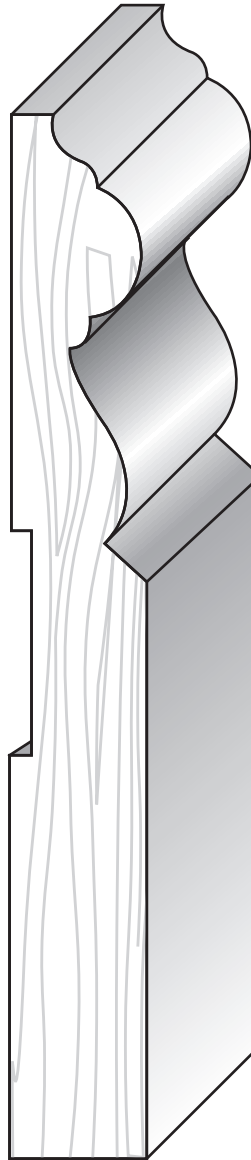

#308 $\frac{3}{4} \times 5\frac{1}{2}$

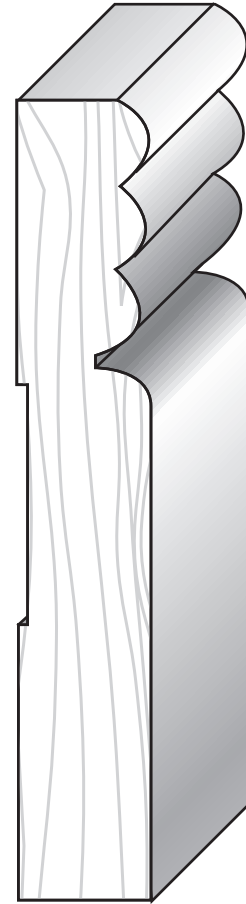

#313 $1\frac{1}{16} \times 4\frac{1}{4}$

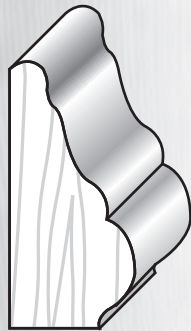

#05 $\frac{5}{8} \times 1\frac{3}{8}$

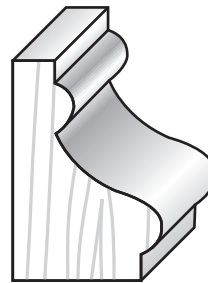

#09 $1\frac{3}{16} \times 1\frac{1}{8}$



BASEBOARD

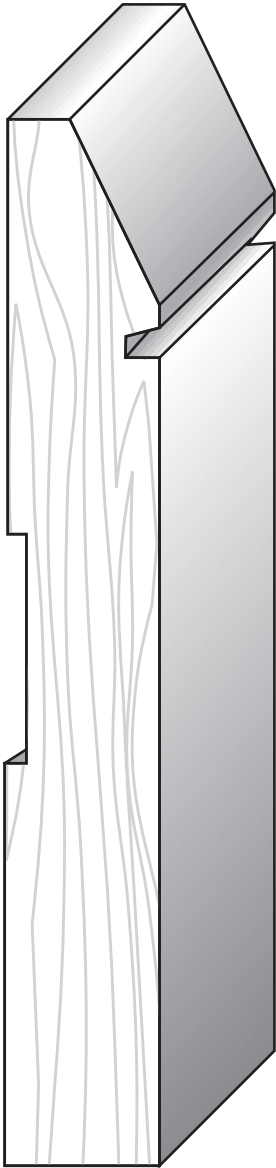

#314 $\frac{3}{4} \times 5\frac{1}{2}$

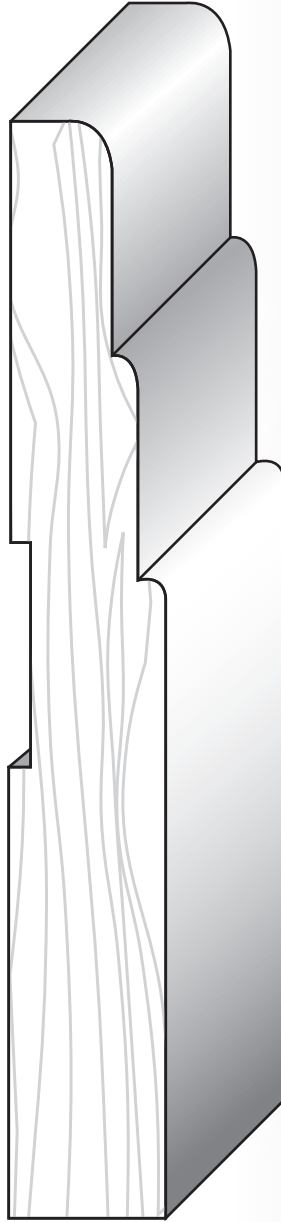

#315 $\frac{3}{4} \times 5\frac{3}{4}$

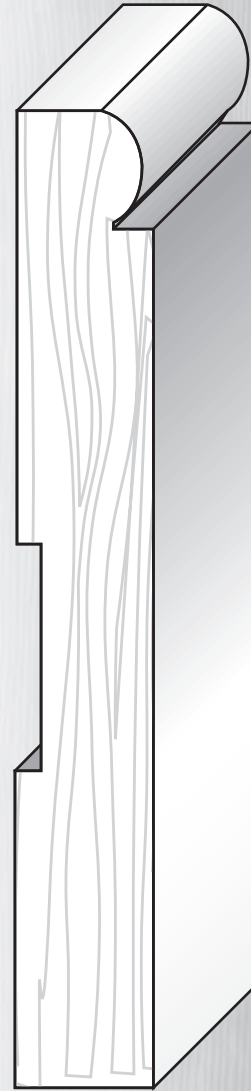

#316 $\frac{11}{16} \times 5\frac{1}{8}$

Smokey Mountain Lumber, Inc.

BASEBOARD

Smokey Mountain Lumber, Inc.

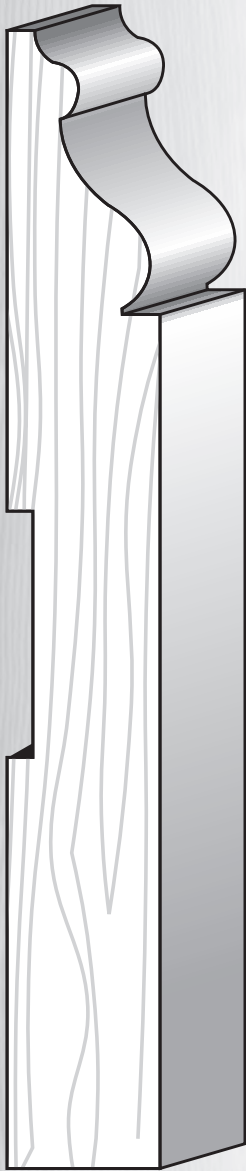

#319 $3/4 \times 5\frac{1}{2}$

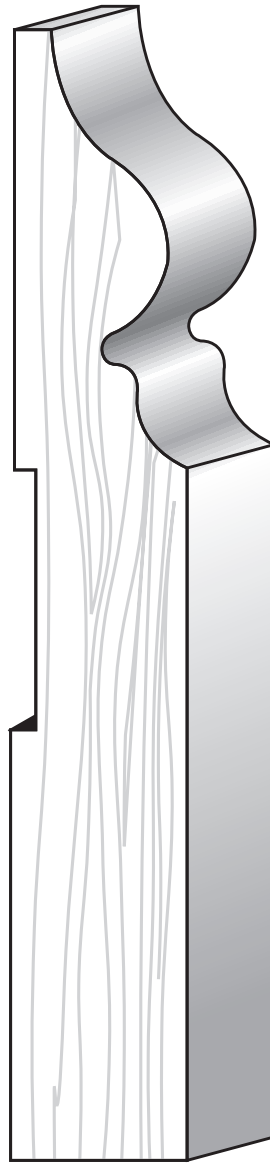

#320 $1\frac{3}{16} \times 5\frac{1}{2}$

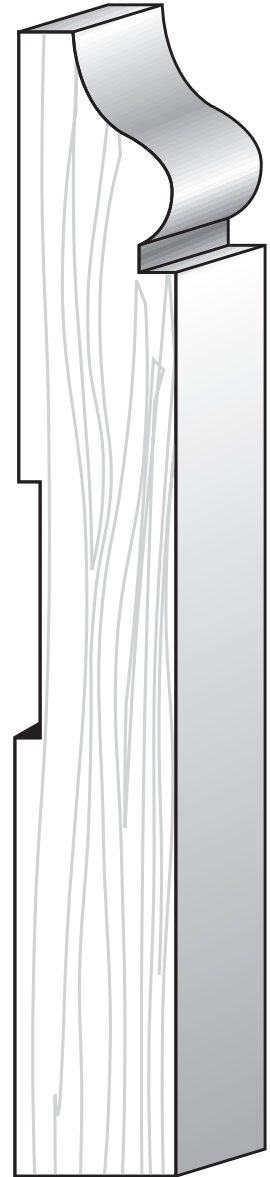

#321 $3/4 \times 5\frac{1}{2}$

BASEBOARD

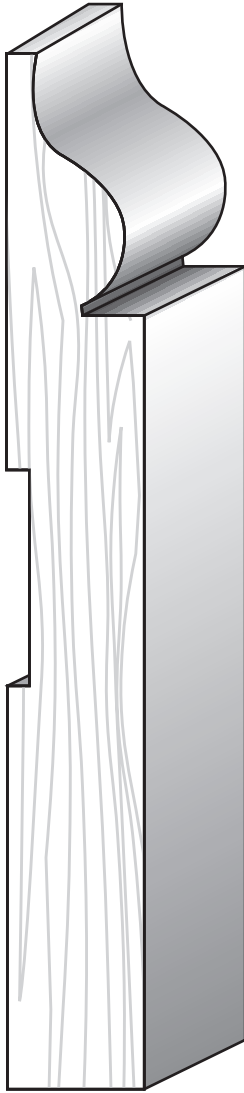

#322 $\frac{3}{4} \times 5\frac{1}{2}$

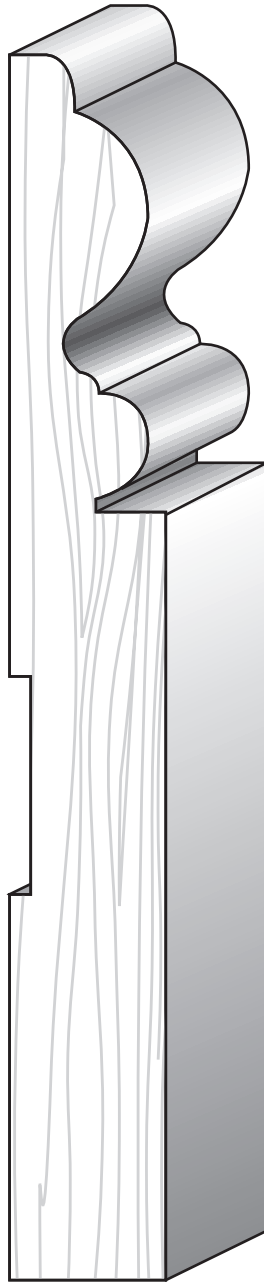

#323 $\frac{13}{16} \times 6\frac{1}{2}$



#324 $\frac{13}{16} \times 5\frac{1}{2}$

Smokey Mountain Lumber, Inc.

BASEBOARD

Smokey Mountain Lumber, Inc.



#325 $\frac{3}{4} \times 6\frac{1}{2}$

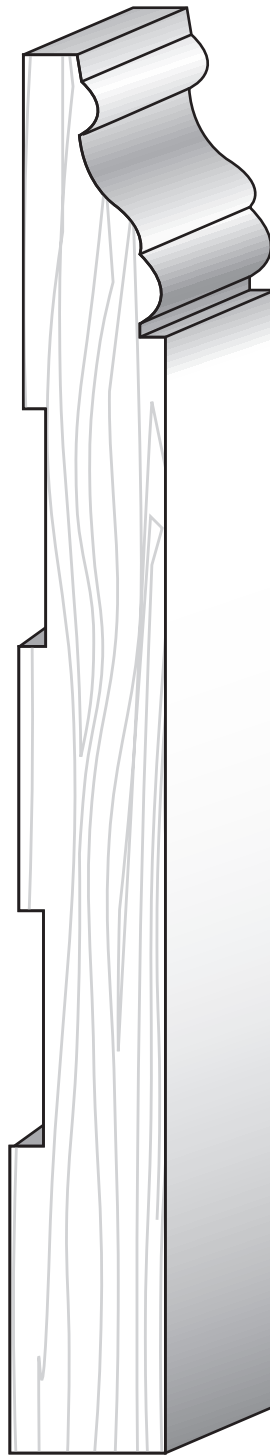

#326 $\frac{3}{4} \times 7\frac{1}{4}$

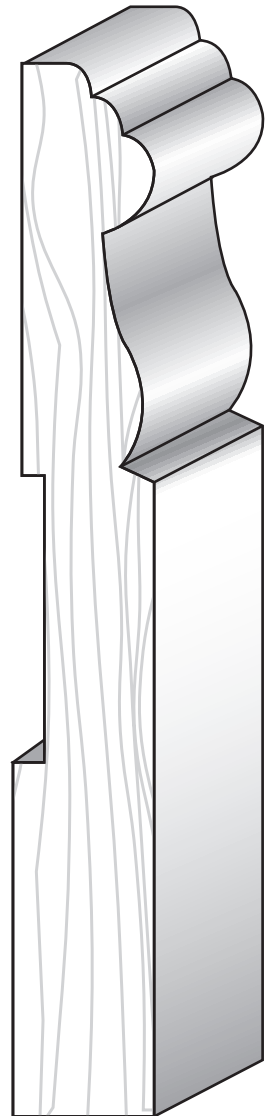

#327 $\frac{3}{4} \times 5\frac{1}{2}$

BASEBOARD

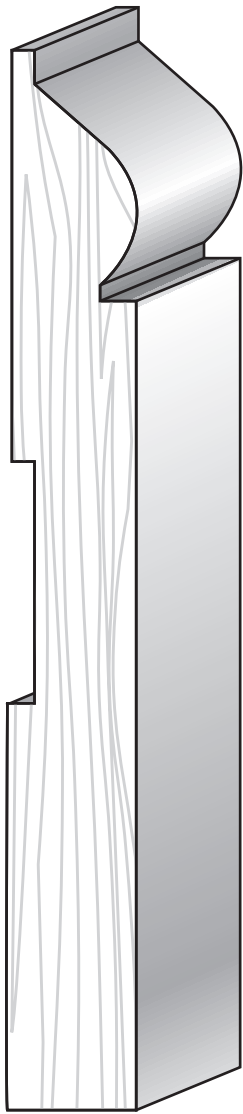

#328 $3/4 \times 5\frac{1}{2}$

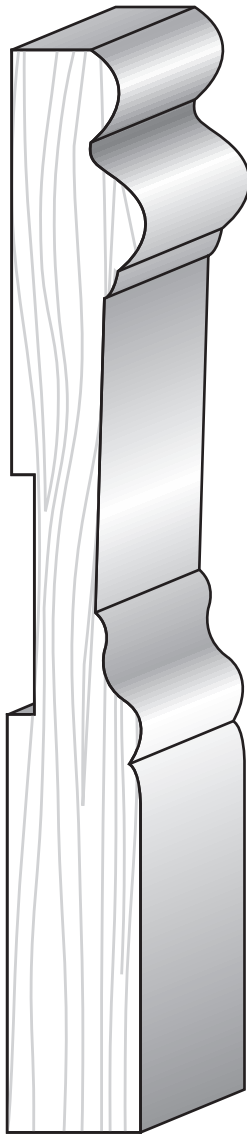

#329 $3/4 \times 5\frac{1}{2}$

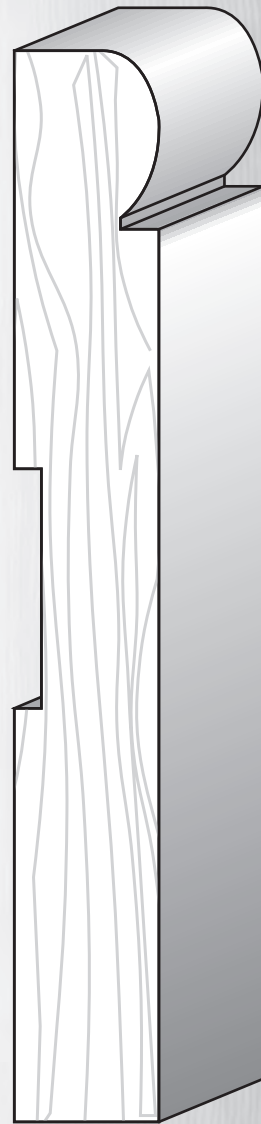

#330 $3/4 \times 5\frac{1}{2}$

Smokey Mountain Lumber, Inc.

BASEBOARD

Smokey Mountain Lumber, Inc.

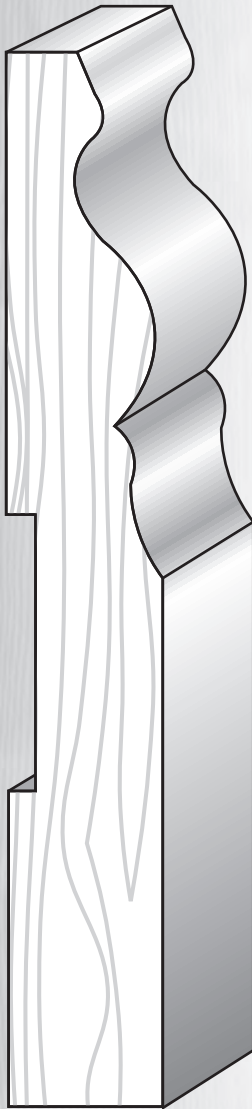

#331 $\frac{3}{4} \times 5\frac{1}{2}$

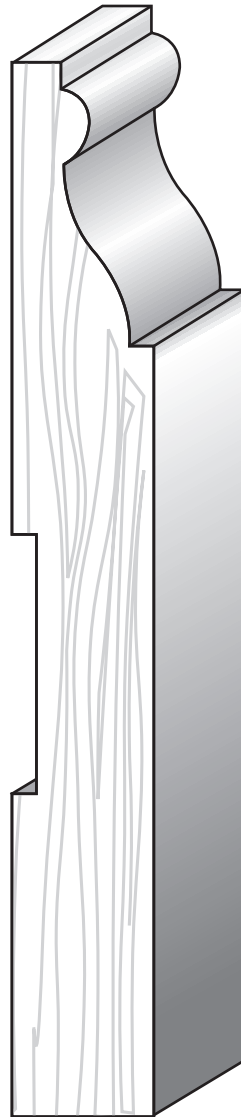

#332 $\frac{11}{16} \times 5\frac{1}{2}$

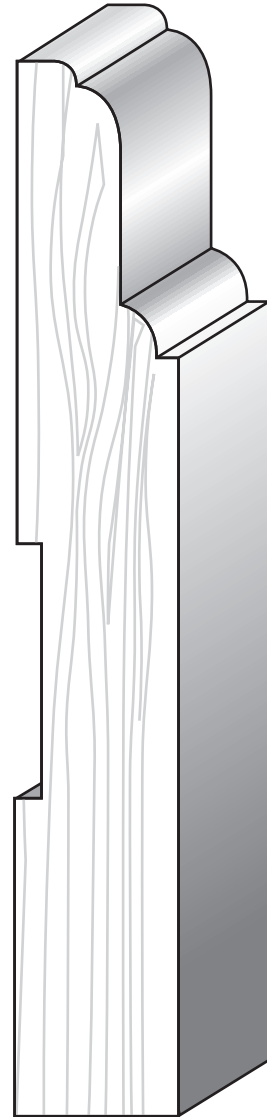

#333 $\frac{13}{16} \times 5\frac{1}{2}$

BASEBOARD

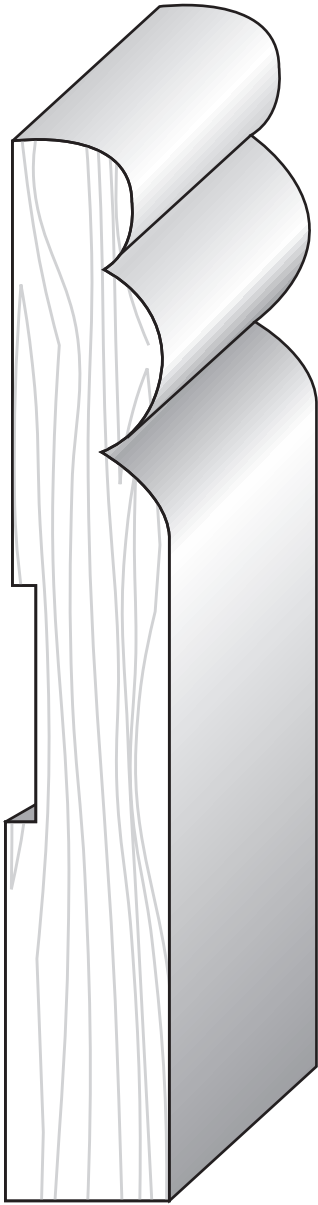

#317 $1\frac{3}{16} \times 5\frac{1}{2}$

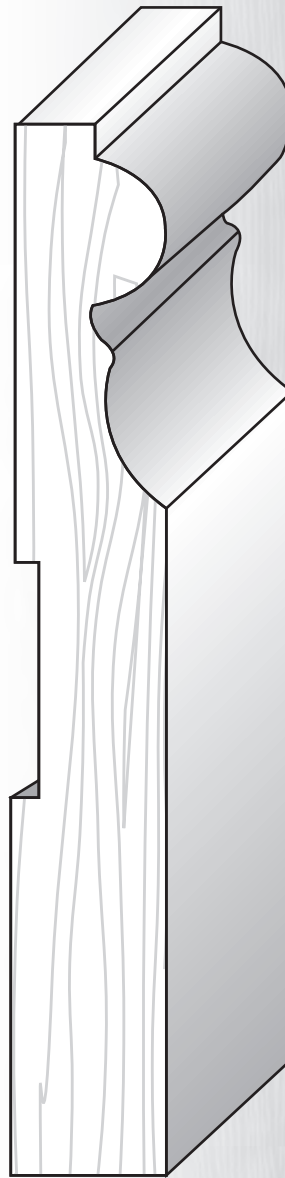

#318 $\frac{3}{4} \times 5\frac{1}{2}$

Smokey Mountain Lumber, Inc.

CHAIRRAIL

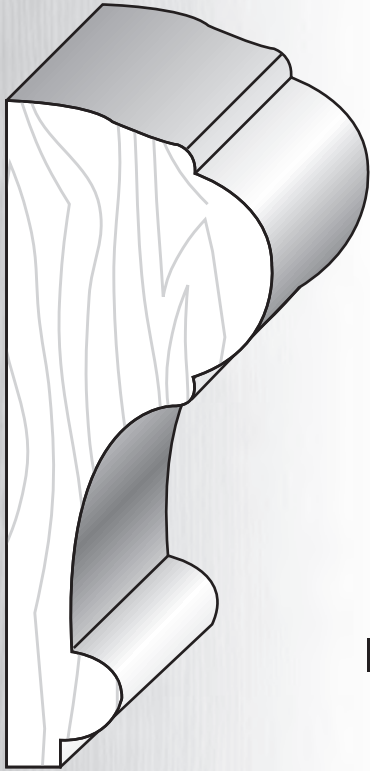

#402 $1\frac{3}{8} \times 3\frac{1}{2}$

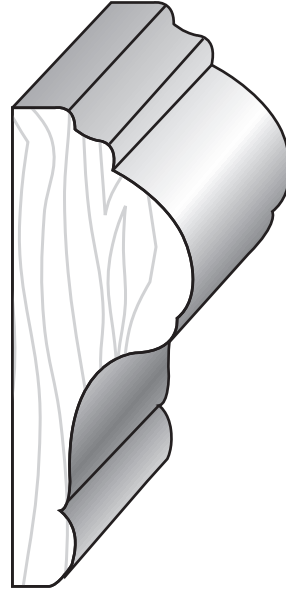

#401 $1\frac{5}{16} \times 2\frac{1}{2}$

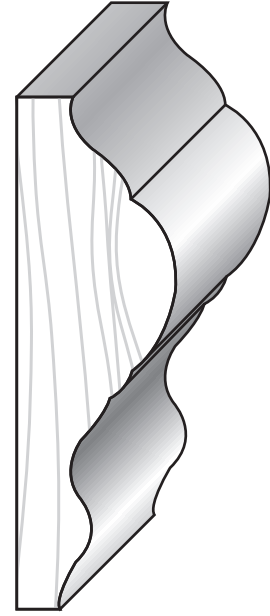

#400 $1\frac{3}{16} \times 2\frac{3}{4}$

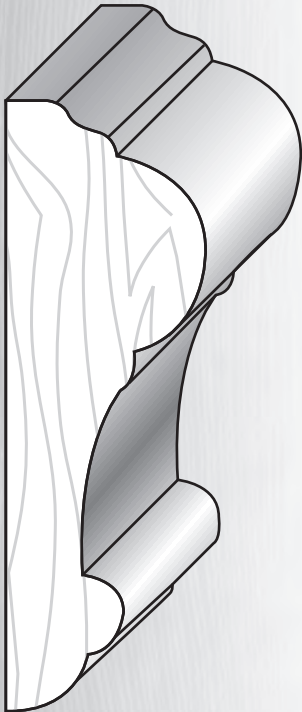

#403 $1 \times 3\frac{1}{4}$

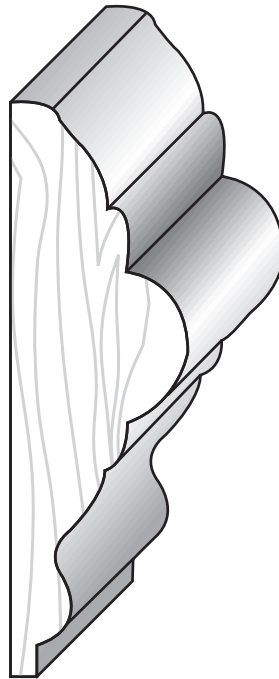

#404 $\frac{7}{8} \times 3$

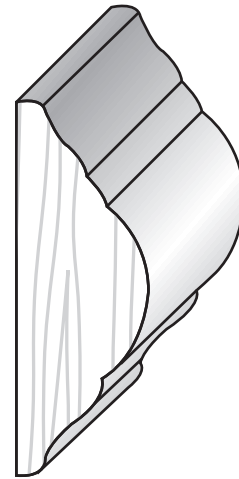

#04 $1\frac{1}{16} \times 1\frac{7}{8}$



CHAIRRAIL

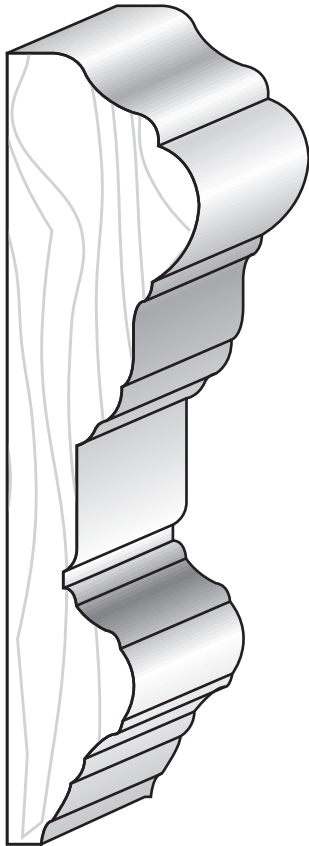

#405 1 x 4¹/₈

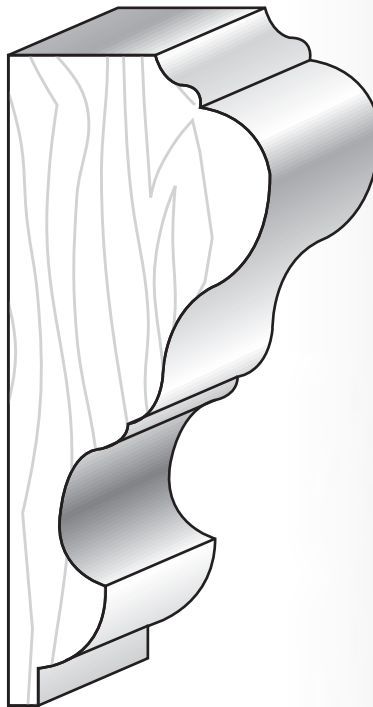

#406 1³/₈ x 3¹/₂

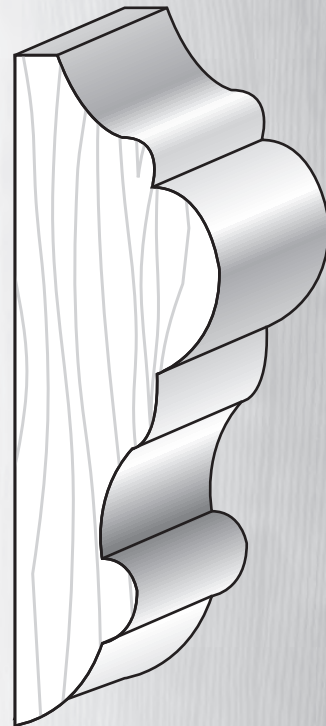

#407 1¹/₁₆ x 3¹/₂

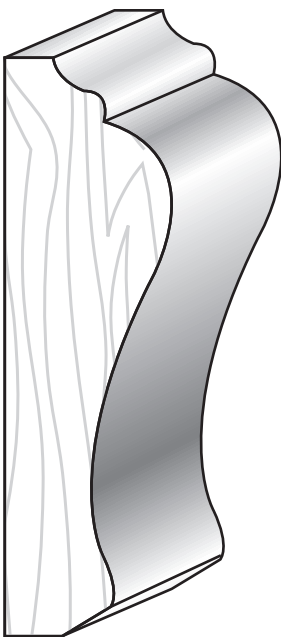

#408 7⁷/₈ x 3

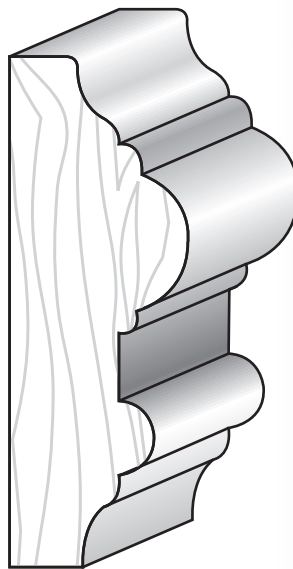

#409 1 x 2⁵/₈

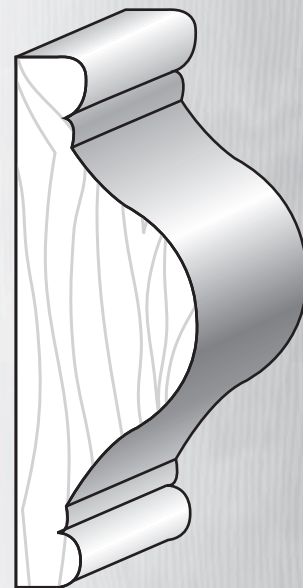

#410 1⁵/₁₆ x 2³/₄

Smokey Mountain Lumber, Inc.

BACKBAND

Smokey Mountain Lumber, Inc.

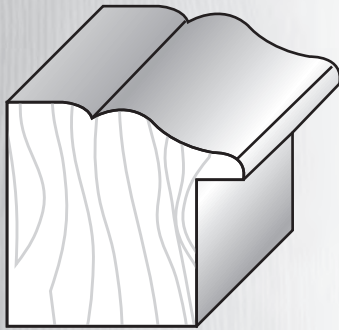

#601 $1\frac{1}{8} \times 1\frac{3}{16}$

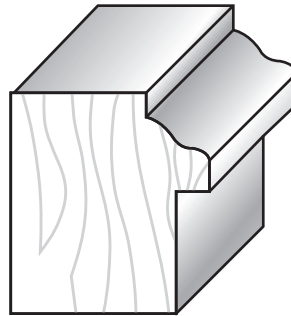

#602 $1\frac{1}{4} \times 1\frac{1}{8}$

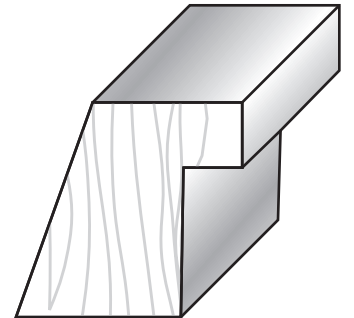

#603 $1\frac{1}{16} \times 1\frac{1}{8}$

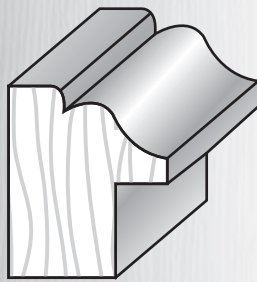

#604 $1\frac{3}{16} \times 1\frac{3}{16}$

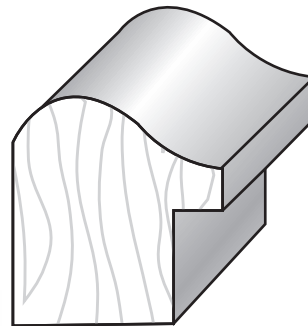

#605 $1\frac{1}{4} \times 1\frac{1}{8}$

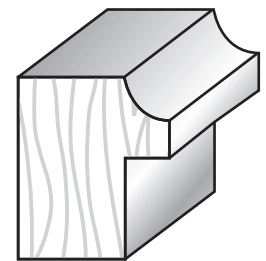

#606 $1\frac{5}{16} \times 1\frac{3}{16}$

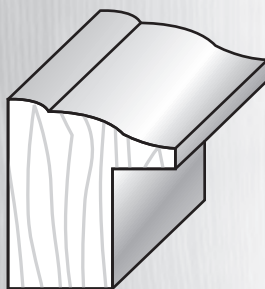

#607 $1 \times \frac{7}{8}$

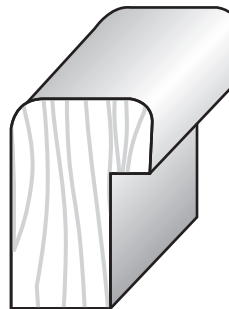

#608 $1\frac{1}{8} \times \frac{3}{4}$

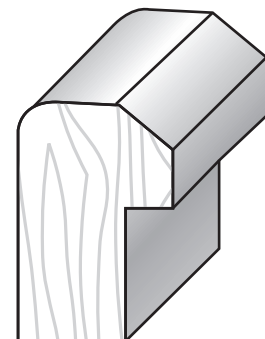

#609 $1\frac{1}{4} \times 1\frac{3}{16}$

BACKBAND

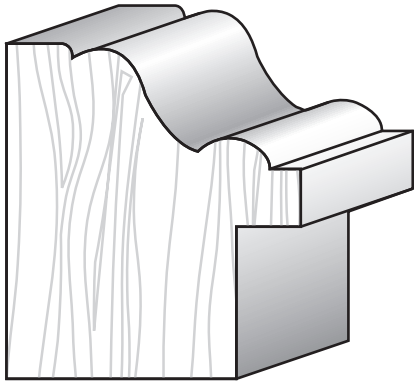

#610 $1\frac{3}{4} \times 1\frac{1}{2}$

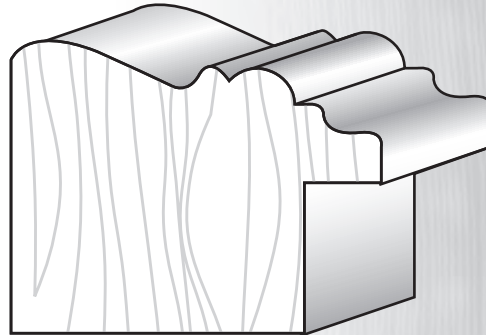

#611 $1\frac{1}{2} \times 1\frac{7}{8}$

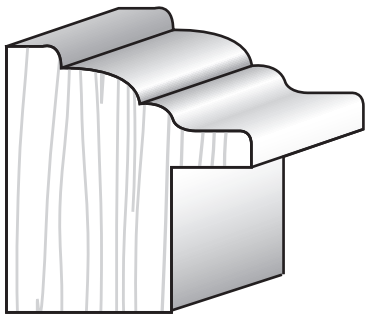

#612 $1\frac{3}{8} \times 1\frac{1}{4}$

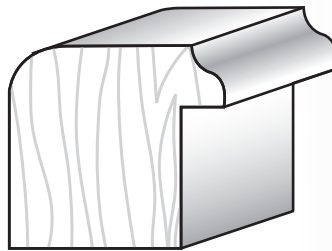

#613 $1\frac{1}{16} \times 1\frac{1}{16}$

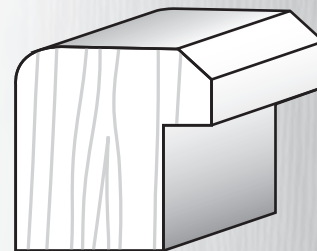

#614 $1\frac{1}{16} \times 1$

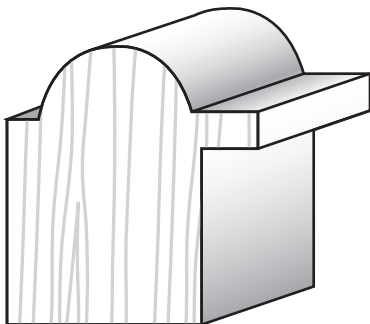

#615 $1\frac{7}{16} \times 1\frac{1}{4}$

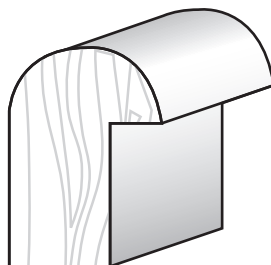

#616 $1\frac{1}{8} \times \frac{3}{4}$

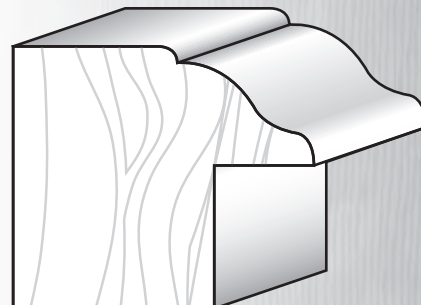

#617 $1\frac{3}{8} \times 1\frac{1}{2}$

Smokey Mountain Lumber, Inc.

Smokey Mountain Lumber, Inc.

MISCELLANEOUS

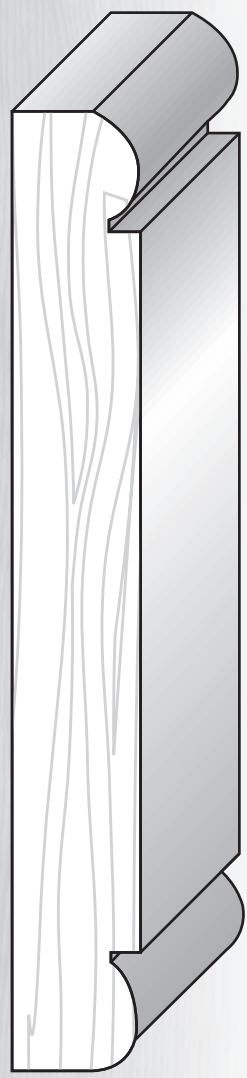

#03 $\frac{5}{8} \times 5$

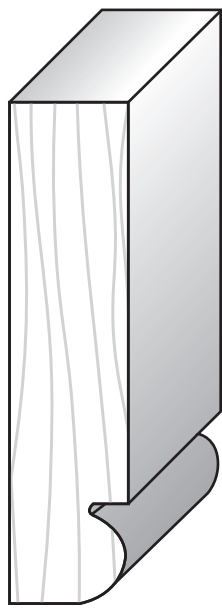

#02 $\frac{5}{8} \times 2\frac{5}{8}$

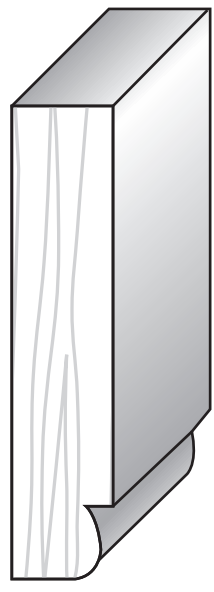

#01 $1\frac{1}{2} \times 2\frac{1}{2}$

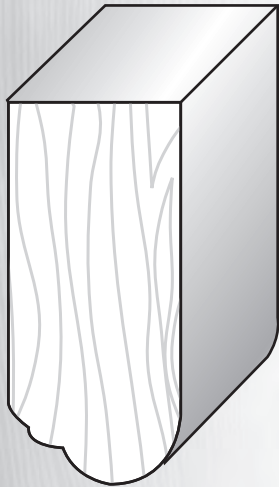

#06 $\frac{7}{8} \times 2$

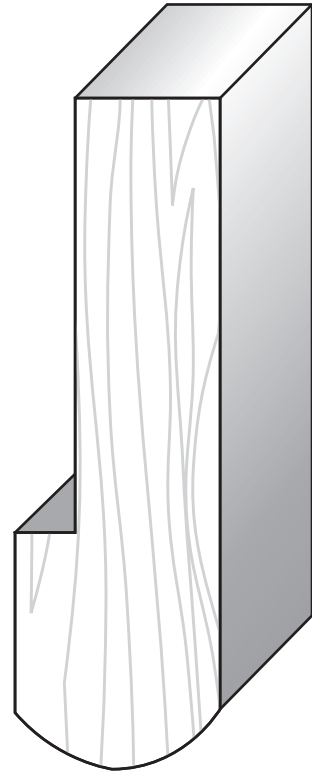

#07 $1\frac{1}{16} \times 3\frac{1}{2}$

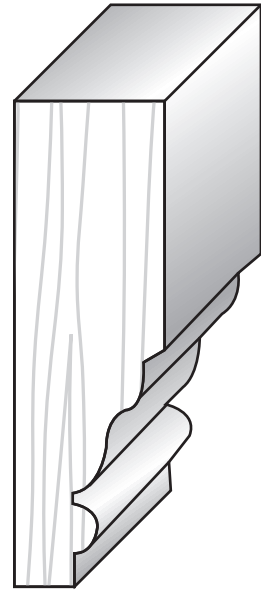

#14 $\frac{3}{4} \times 2\frac{1}{2}$



Smokey Mountain Lumber
INCORPORATED

MISCELLANEOUS

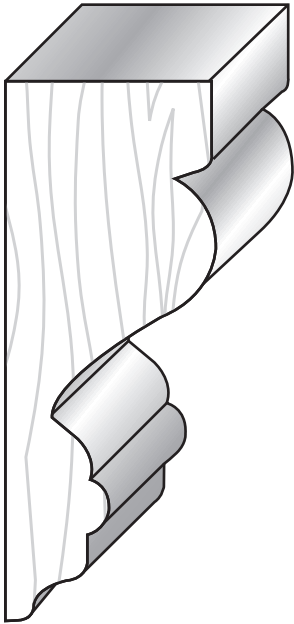

#34 1 x 2^{13/16}

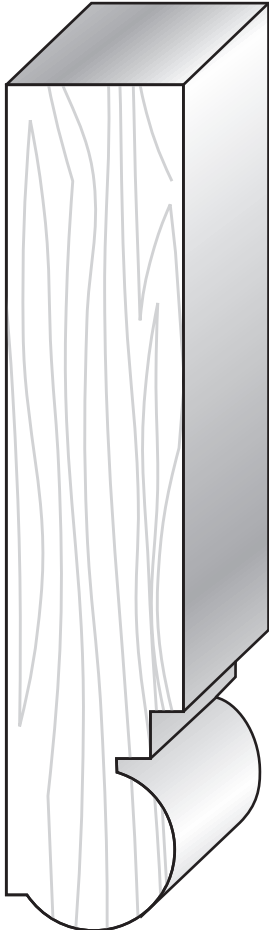

#35 7/8 x 4^{1/2}

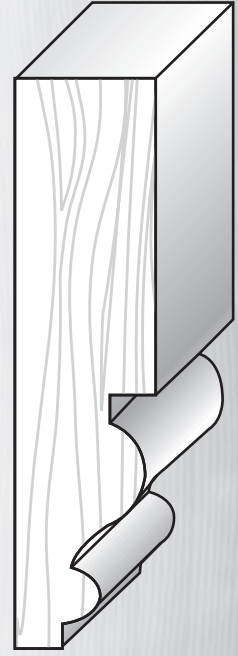

#36 1^{1/16} x 3

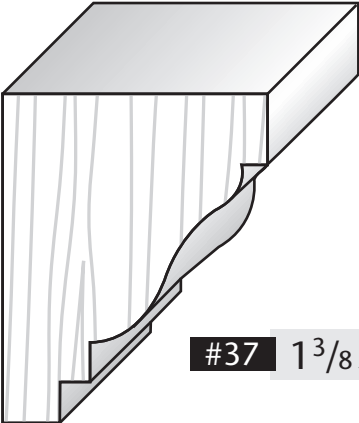

#37 1^{3/8} x 1^{3/4}

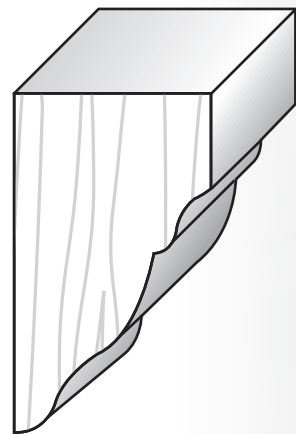

#40 1 x 1^{3/4}



#38 5/8 x 2

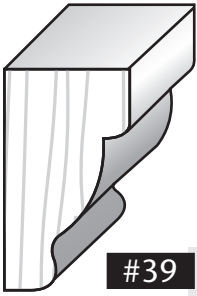

#39 5/8 x 1^{1/8}

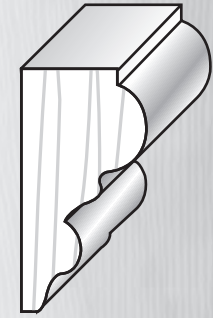

#41 5/8 x 1^{1/4}

Smokey Mountain Lumber, Inc.

828.298.3958

MISCELLANEOUS

Smokey Mountain Lumber, Inc.

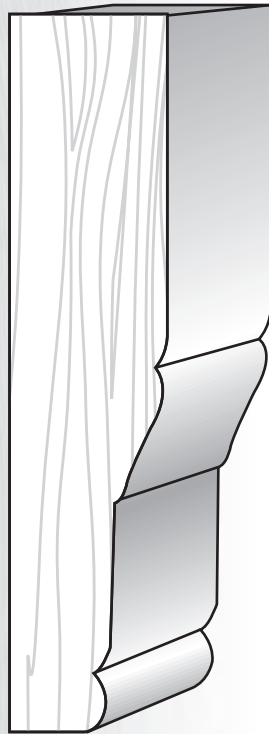

#32 $1\frac{3}{16} \times 3\frac{3}{4}$

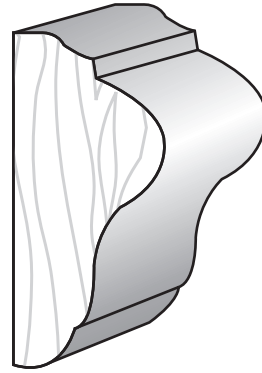

#29 $1\frac{3}{16} \times 1\frac{3}{4}$

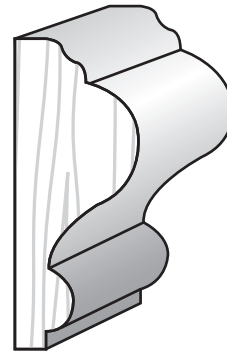

#30 $\frac{5}{8} \times 1\frac{11}{16}$

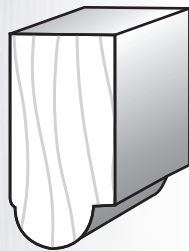

#28 $\frac{1}{2} \times 1\frac{1}{8}$

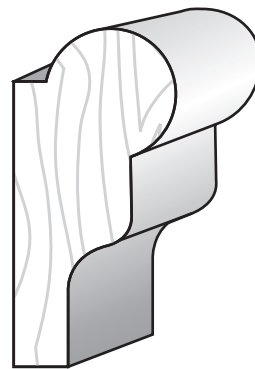

#31 $\frac{3}{4} \times 1\frac{13}{16}$

MISCELLANEOUS

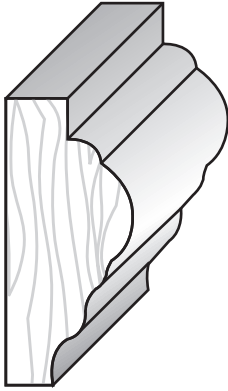

#16 $\frac{5}{8} \times 1\frac{1}{2}$

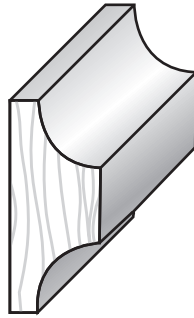

#17 $\frac{7}{16} \times 1\frac{1}{8}$

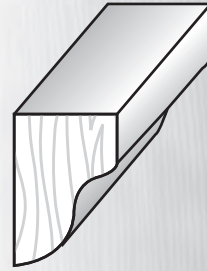

#18 $\frac{9}{16} \times \frac{3}{4}$

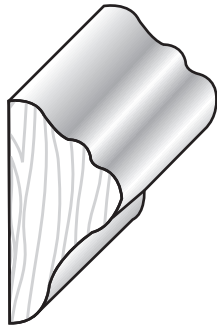

#21 $\frac{9}{16} \times 1\frac{1}{8}$

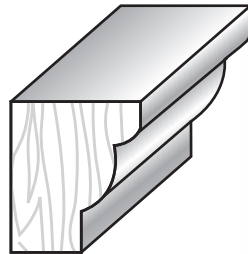

#19 $1\frac{1}{16} \times \frac{3}{4}$

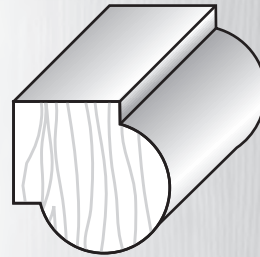

#22 $\frac{13}{16} \times \frac{13}{16}$

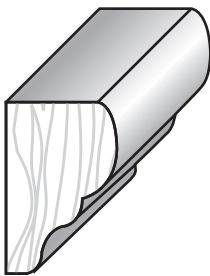

#24 $\frac{5}{8} \times \frac{7}{8}$

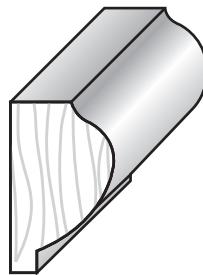

#23 $\frac{1}{2} \times \frac{7}{8}$

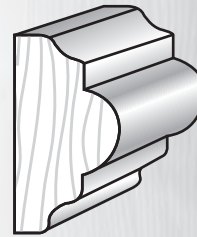

#33 $\frac{9}{16} \times 1$

Smokey Mountain Lumber, Inc.

MISCELLANEOUS

Smokey Mountain Lumber, Inc.

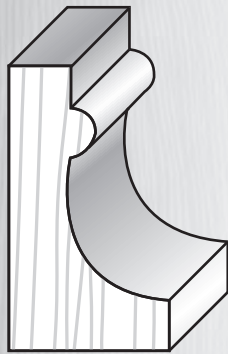

#42 $1\frac{3}{16} \times 1\frac{1}{2}$

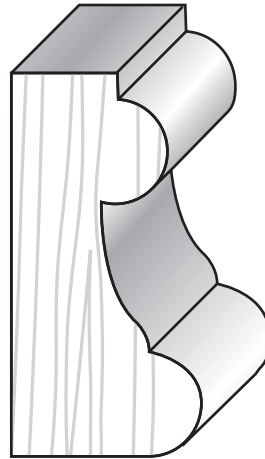

#43 1 x 2

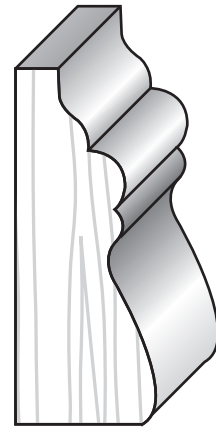

#44 $1\frac{1}{16} \times 1\frac{7}{8}$

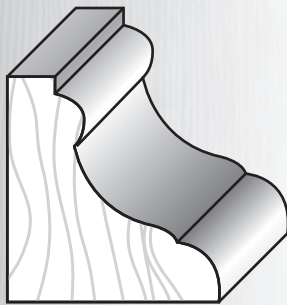

#45 $1\frac{3}{16} \times 1\frac{1}{8}$

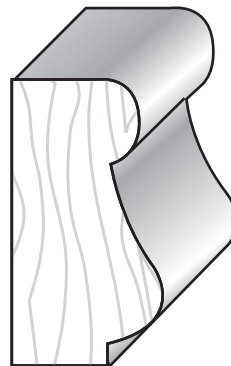

#46 $\frac{3}{4} \times 1\frac{1}{2}$

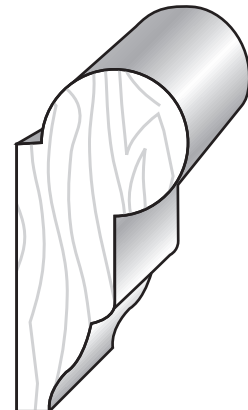

#47 $\frac{7}{8} \times 1\frac{3}{4}$

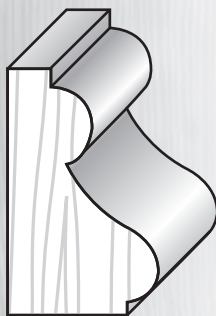

#48 $\frac{3}{4} \times 1\frac{1}{4}$

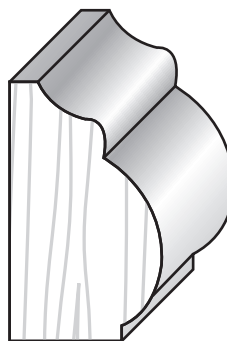

#49 $\frac{3}{4} \times 1\frac{3}{8}$

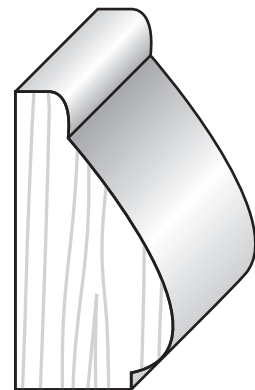

#50 $1\frac{3}{16} \times 1\frac{1}{2}$

MISCELLANEOUS

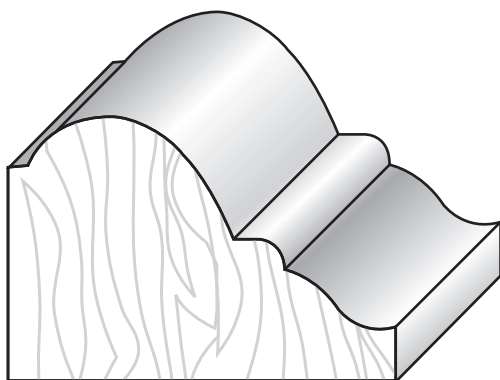

#51 $1\frac{3}{8} \times 2$

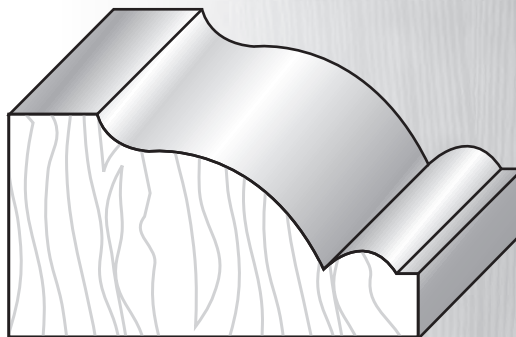

#52 $1\frac{3}{16} \times 2\frac{1}{8}$

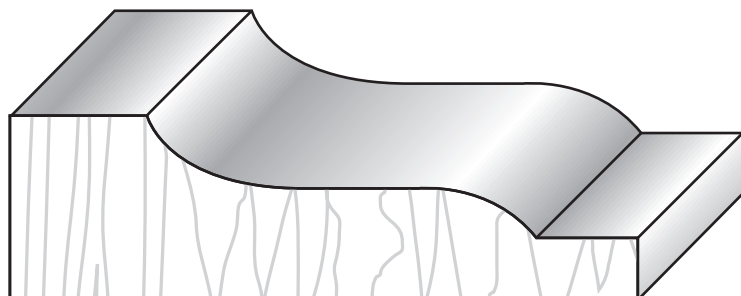

#53 $1 \times 3\frac{1}{4}$

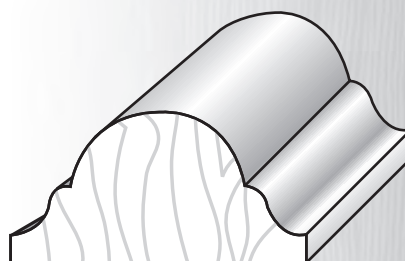

#54 $\frac{3}{4} \times 1\frac{1}{2}$

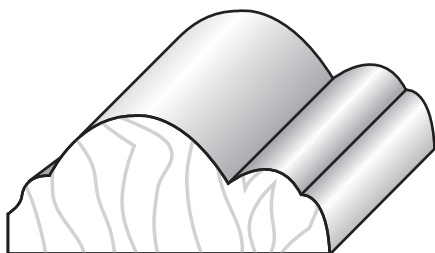

#55 $1\frac{1}{16} \times 1\frac{3}{16}$

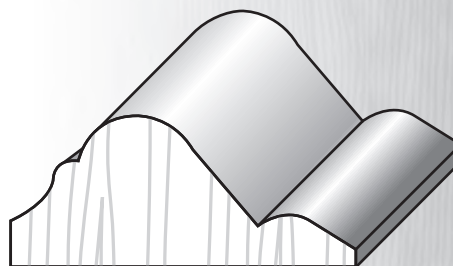

#56 $\frac{3}{4} \times 1\frac{3}{4}$

Smokey Mountain Lumber, Inc.

DOORSTOP

Smokey Mountain Lumber, Inc.

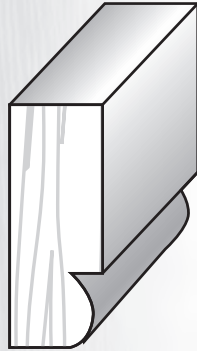

#25 $7/16 \times 1\frac{1}{4}$

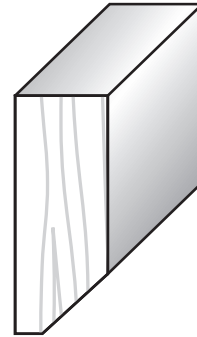

#26 $7/16 \times 1\frac{1}{4}$

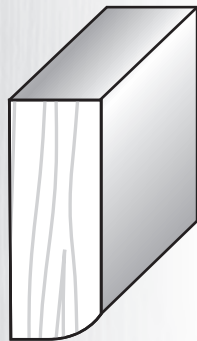

#20 $7/16 \times 1\frac{1}{4}$

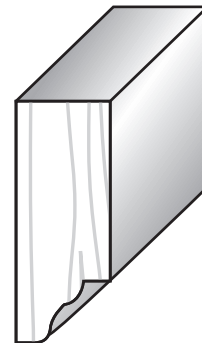

#27 $7/16 \times 1\frac{1}{4}$



ARTWORK MAY NOT BE TRUE TO SIZE